

Bexen

Monitor Defibrillator

=====**Reanibex 700**=====

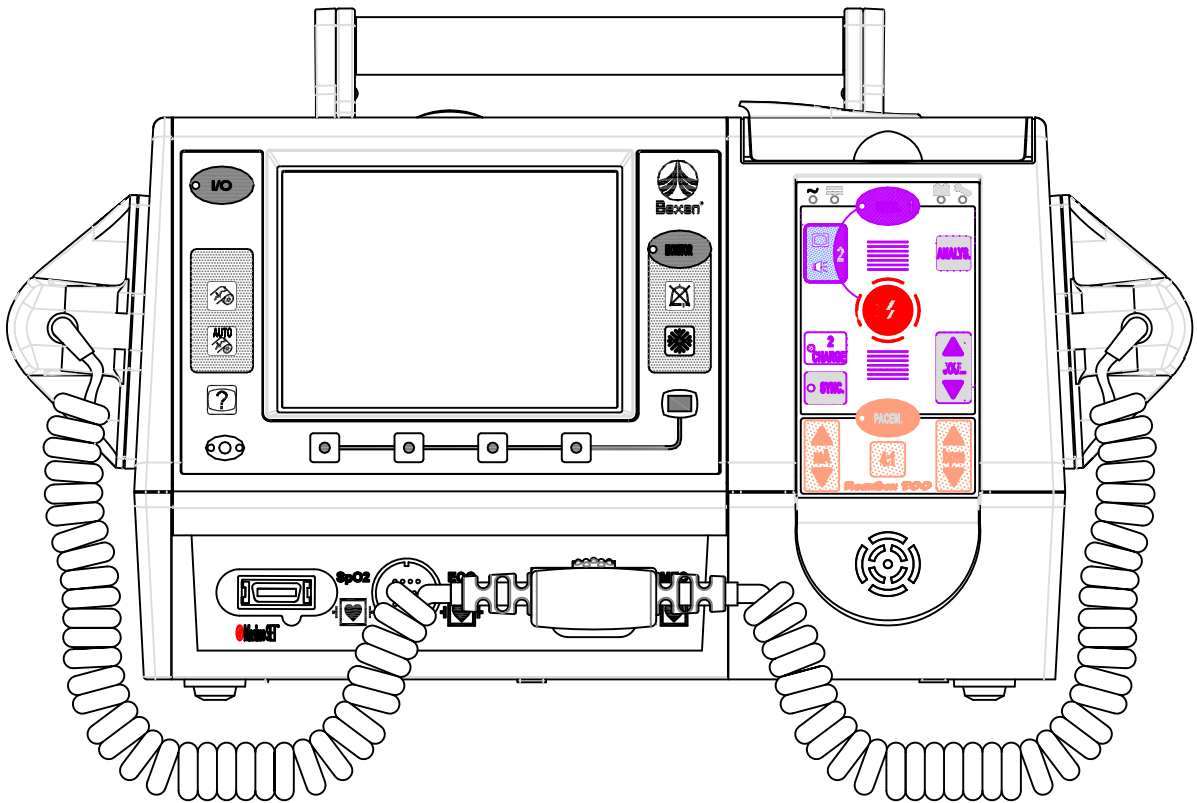

USER MANUAL

DGH 700 B - Rev: K / 2012.MAR.

REANIBEX Serie 700

User Manual

Approved: R & D Director	Revision: K
	Date: March 2012

Revision: K

03/2012

All rights are reserved rights for this publication.

This manual may not be totally or partially reproduced, in any way or by any means, without prior written authorisation from OSATU S.Coop.

The information contained in this manual may be modified with no need for prior notification by the manufacturer. If the information given in this User Manual does not correspond to the operation of the unit, please contact an authorised representative of OSATU S.Coop.

REANIBEX Serie 700

This is a product of: **OSATU S.Coop**

Edificio Zearrekobuelta

Subida de Areitio N° 5

48260 Ermua (Bizkaia) – SPAIN

Tel: +34 943 17 02 20

Fax: +34 943 17 02 27

e-mail: osatu@bexencardio.com

www.bexencardio.com

DECLARACIÓN DE CONFORMIDAD
DECLARATION OF CONFORMITY

Directiva del Consejo con la que se declara conformidad:
Council Directive to which conformity is declared:
Annex II, section 3 of CD 93/42/EEC concerning medical devices

Aplicación de las Normas / *Application of the Standards:*
**IEC 60601-1 (1988) + A1 (1993) + A11 (1994) + A12 (1994) + A13 (1997) +
A2 (1995), IEC 60601-1-2 (2007), IEC 60601-2-4 (2002), IEC 60601-2-25 (1993) +
A1 (1999), IEC 60601-2-27 (2005) , IEC 60601-2-49 (2001) + ISO 9919 (2005)**

Fabricante / *Manufacturer's name:* **Osatu S. Coop.**

Dirección / *Manufacturer's address:* **Edificio Zearrekobuelta
Subida de Areitio N° 5
48260-Ermua
Bizkaia (SPAIN)**

Tipo de equipo / *Type of equipment:* **Monitor Desfibrilador Manual/AED
Manual Defibrillator Monitor/AED**

Marca / *Trademark:* **BEXEN**

Modelo / *Model No.:* **REANIBEX SERIE 700
ELIFE 700
RELIFE 700**

Clasificación / *Classification:* **Class IIb**

Organismo notificado / *Notified body:* **Underwriters Laboratories (CE-0843)**

**Nosotros, los abajo firmantes, declaramos que el equipo antes especificado cumple
con las Directivas y las Normas mencionadas**
**We, the undersigned, hereby declare that the equipment specified above conforms
to the provisions set forth in the Directives and Standards**

Fecha / *Date:* 12/03/2012



(Firma / *Signature*)
Felix Ajuria
Managing Director

CONTENTS

1. Introduction to the REANIBEX Serie 700	1
1.1 General Description	1
1.2 Indications for Use	3
1.2.1 Monitoring	3
1.2.2 Defibrillation	3
1.2.2.1 Manual Defibrillation	4
1.2.2.2 Semi-Automatic Defibrillation (Optional)	4
1.2.3 Synchronized Cardioversion	5
1.2.4 Non-invasive Pacemaker (Optional)	5
1.3 Precautions	6
2. Description of the Device	10
2.1 Components of the REANIBEX Serie 700	10
2.1.1 Front view	10
2.1.2 Overhead view	12
2.1.3 Rear view	13
2.2 Front panel	14
2.2.1 Monitor Mode	15
2.2.2 Defibrillator Mode	15
2.2.3 Pacemaker Mode (Optional)	16
2.3 Screen	17
2.4 Paddles, Electrodes and Patient Cables	18
2.5 Battery	20
2.6 Events	20
2.7 Menu Options	22
2.7.1 Alarms Menu	22
2.7.2 Report Menu	23
2.7.3 Recorder Menu	25
2.7.4 Interface Menu	26
3. Installation of the Device	27
3.1 General	27
3.2 Cables	28
3.3 Battery	29
3.4 Recorder (Optional)	30
3.5 Compact Flash Memory Card (Optional)	30
4. Monitoring	33
4.1 Description	33
4.2 Warnings	34
4.3 ECG Monitoring Procedure	34

4.3.1	Use of paddles and single-use multifunction electrodes	34
4.3.2	Use of patient cable	36
4.3.3	Positioning the monitoring electrodes	37
4.4	Selecting the size and the lead	39
4.5	Selecting the Filter	41
4.6	Alarms	41
4.6.1	HR and SpO2 Alarms	44
4.6.2	VT/VF Alarm	44
5.	<i>Manual Defibrillation</i>	46
5.1	Description	46
5.2	Warnings	48
5.3	Preparation for Defibrillation	50
5.3.1	Utilization of Multifunction Single-Use Electrodes	51
5.3.2	Utilization of Reusable External Paddles	52
5.3.3	Utilization of Paediatric Paddles	53
5.3.4	Utilization of Internal Paddles	54
5.4	Defibrillation Procedure	54
6.	<i>Synchronized Cardioversion</i>	59
6.1	Description	59
6.2	Warnings	60
6.3	Preparation for Synchronized Cardioversion	60
6.4	Synchronized Cardioversion Procedure	61
7.	<i>Semi-Automatic Defibrillation (AED) (Optional)</i>	63
7.1	Description	63
7.2	Warnings	65
7.3	Preparation for Semi-Automatic Defibrillation	66
7.4	Semi-Automatic Defibrillation Procedure	67
8.	<i>Transcutaneous Pacemaker (Optional)</i>	71
8.1	Description	71
8.2	Warnings	72
8.3	Preparation for pacing with the Pacemaker	73
8.4	Fixed Mode and On-Demand Mode	74
8.5	Pacemaker Pacing Procedure	75
9.	<i>Pulse Oximetry (optional)</i>	77
9.1	Description	77
9.2	Warnings	78
9.3	Operation of the pulse oximetry	80
9.4	Pulse Oximetry Sensors	81

9.5	Monitoring pulse oximetry	83
10.	<i>Recorder (Optional)</i>	85
10.1	Description	85
10.2	Configuration of the recorder	85
10.3	Operating the recorder	86
11.	<i>Configuration Mode</i>	89
11.1	Description	89
11.2	Main Menu	90
11.3	Date / Time	91
11.4	General	92
11.5	Configuration	94
11.5.1	Modules	95
11.5.1.1	Monitor	95
11.5.1.2	Manual Defibrillator	97
11.5.1.3	Automatic Defibrillator	99
11.5.1.4	Pacemaker	101
11.5.1.5	Recorder	102
11.5.2	Default Values	104
11.5.3	Configuration Passcode	107
11.5.4	Manual Mode Passcode	108
11.5.5	Equipment Identifier	108
11.6	Information	109
11.6.1	Device Information	109
11.6.2	History	110
11.6.3	Device Test Results	111
11.7	Tests	113
11.7.1	Hardware Test	114
11.7.2	Accessories Test	115
11.7.3	Front Panel	117
11.7.4	Paddle Interface	118
11.8	Print Configuration	118
11.9	Compact Flash	120
11.9.1	Information	121
11.9.2	Printing Events	122
11.9.3	Deleting Episodes	124
11.9.4	Formatting	124
11.10	Changing the Configuration Options	124
12.	<i>Managing and Reviewing Data</i>	127
13.	<i>Maintenance of the Device</i>	131
13.1	General	131
13.2	Routine Maintenance	132
13.3	Repairs and Overhauls	133

13.4	Cleaning	134
13.4.1	Sterilization of the internal paddles	135
13.5	Fuse replacement	136
13.6	Storage	136
13.7	Battery	137
13.8	Recycling	139
13.9	Check list	140
14.	Troubleshooting	141
A.1	Symbols of the REANIBEX Serie 700	149
A.2	Screen Symbols	152
A.3	Battery Symbols	154
A.4.	List of Events	156
A.5	On-screen and/or audible messages	157
A.6	Device Events	159
A.7	Device Labels	162
A.8	Battery Label	164
A.9	Technical Specifications	166
A.10	Waveform Specifications	175
A.11	Manufacturer's Guide and Declaration of Electromagnetic Compatibility	177
A.12	Accessories	183

Blank sheet

Blank sheet

1. Introduction to the REANIBEX Serie 700

1.1 General Description

The REANIBEX Serie 700 is a Monitor/Defibrillator system which provides advanced functions for monitoring and acute cardiac care response using the four available modes of operation: Monitor with pulse oximetry (SpO₂) option, Manual Defibrillator, Semi-automatic defibrillator (optional) and Transcutaneous External Pacemaker (optional). It is a portable and lightweight device, designed with the latest groundbreaking technologies in the field of defibrillation such as the state-of-the-art biphasic waveform.

The unit incorporates a wide screen that allows viewing, not only of the ECG signal, but also the monitoring parameters for both the patient and the device, warning messages and user guide messages.

In Monitor mode the REANIBEX Serie 700 can pick up the signal via the 4, 5 or 10 lead patient cable, or via the adult or paediatric external reusable paddles or via the single-use multifunction electrodes.

In the Manual Defibrillator mode, if the patient needs a defibrillation shock, this is easily administered by following the three steps below:

- 1- Select the energy level
- 2- Charge
- 3- Shock

When operating in Semi-Automatic Defibrillator mode (optional) the REANIBEX Serie 700 analyzes the electrocardiogram (ECG) of the patient, and determines if the rhythm analyzed can be defibrillated, in which case it requires a manoeuvre by the user to deliver the shock. During the whole process, the device displays on-screen text messages, and provides audible messages by means of a high-fidelity speaker system located in the front panel, that guides the user in his manoeuvre, which means the use of the device in this mode requires basic training.

The Pacemaker mode (optional) provides non-invasive transcutaneous stimulation delivering pulses via single-use multifunction electrodes.

The REANIBEX Serie 700 has a user-configurable high resolution recorder which can print the waveforms and operation entries.

In addition to these patient-based operating modes, the REANIBEX Serie 700 has a special start-up mode that provides direct access to the Configuration mode, where users can configure and adapt the parameters which control the operation of the device to accommodate their needs.

The REANIBEX Serie 700 can operate with NiMH rechargeable batteries, or it can be connected to an AC power supply network or car battery. The battery status indicator is constantly displayed in the top part of the screen. Additionally, when the device is connected to an external power supply (AC mains or car battery) the battery is automatically charged, by means of an internal charger, regardless of whether the device is switched on or off.

WARNING: If the power supply is interrupted for more than 30 seconds, when the power is restored the device settings return to the values set in the configuration. If the power supply interruption is less than 30 seconds, then the values of the parameters set by the user during the actuation are maintained.

The REANIBEX Serie 700 performs a number of self-tests at start-up and while in operation that detects any malfunction or anomalous condition that may occur internally and which could cause the device to become unsafe for use. A malfunction indicator, located on the front panel of the device, indicates detected error conditions as well as displaying on-screen error messages.

The device can also perform various self-tests as requested by the user, using the Configuration mode options.

Finally, the REANIBEX Serie 700 has the option of automatically storing information about the actions performed with the device in a removable Compact Flash external memory card. This data includes the patient's ECG, the events that occurred during the utilization and the audio (optional) of both of the device and the background noise; provided that the device is operating in Automatic Defibrillator mode. In addition to this information, the last 100 events / incidences that occurred during the utilization are stored, grouped according to the utilization to which they belong. All this information can be downloaded, viewed and stored using the "VISOR ECG CONTROL" program.

1.2 Indications for Use

The REANIBEX Serie 700 device is indicated for use in hospital and out-of-hospital settings by medical personnel who have been specially qualified by training in Basic Life Support (BLS), Advanced Life Support (ACLS) techniques or in any other type of acute cardiac emergency response techniques recognised by the competent authority.

The REANIBEX Serie 700 must be used on solely one patient at a time.

1.2.1 Monitoring

The Monitor mode of the REANIBEX Serie 700 allows 4.5 second viewing (9 seconds in cascaded mode) of the patient's ECG picked up on the 4, 5 and 10 lead patient cable, on the reusable external paddles or on the single-use multifunction electrodes.

In addition to those devices in which this option is available, the oxygen saturation (SpO₂%) can be viewed as well as the pleth waveform. Pulse Oximetry is a non-invasive technique used to measure the percentage of haemoglobin molecules which are saturated with oxygen.

WARNING: Under various conditions such as haemoglobin saturation with compounds other than oxygen, hypothermia, patient movement, nail polish and excessive light could cause the pulse oximetry readings to be inaccurate.

1.2.2 Defibrillation

Defibrillation is the only effective treatment for cardiac arrest caused by an abnormal rhythm that can be defibrillated. In such phenomena, the cardiac muscle is beating in an abnormal rhythm, producing a polarized and stress effect whose origin can be due to multiple causes.

The REANIBEX Serie 700 delivers a defibrillation shock by means of a biphasic truncated exponential pulse. The energy from this pulse is delivered to the patient via reusable external

paddles or single-use multifunction electrodes that are connected to the device and to the bare chest of the patient.

1.2.2.1 Manual Defibrillation

Manual Defibrillation or Asynchronous Defibrillation is the primary treatment recommended for patients who suffer episodes of Ventricular Fibrillation (VF) and pulseless Ventricular Tachycardia (VT). Its use is not recommended for patients who suffer asystole and, generally speaking, for patients that present one or more of the following symptoms:

- the patient is conscious
- has a detectable pulse
- breathes spontaneously

1.2.2.2 Semi-Automatic Defibrillation (Optional)

The REANIBEX Serie 700, when operating in Automatic Defibrillator mode, must be used only in adult patients that present symptoms of suffering sudden cardiac arrest which are:

- the patient is unconscious,
- does not have detectable pulse
- does not breath spontaneously

WARNING: The REANIBEX Serie 700, when operating in Automatic Defibrillator mode, is not designed for the treatment of cardiac arrests in paediatric patients and therefore it must not be used in patients under eight years of age or who weigh less than 25 kg.

WARNING: The REANIBEX Serie 700, when in Semi-Automatic Defibrillator mode, must never be used in patients who are conscious, who have a pulse or who breathe spontaneously.

WARNING: Do not analyse in moving vehicles when the device is operating in Semi-Automatic mode. Interference caused by motion artifact can affect the device and may result in erroneous diagnoses. Motion detection may also delay analysis.

WARNING: Do not move the device during analysis when operating in Semi-Automatic Defibrillator mode. Moving the device can result in erroneous diagnoses. Do not touch the patient or the device during analysis.

WARNING: The detection sensitivity of the REANIBEX Serie 700 to arrhythmias that can be defibrillated in patients with implanted cardiac pacemakers can be diminished.

1.2.3 Synchronized Cardioversion

Synchronized Cardioversion is the recommended treatment for patients who suffer episodes of Atrial Fibrillation.

The REANIBEX Serie 700, when operating in Synchronized Cardioversion mode, delivers a biphasic defibrillation shock synchronized with the R wave on the patient's ECG (immediately after it).

1.2.4 Non-invasive Pacemaker (Optional)

Non-invasive transcutaneous stimulation is an established and proven technique, which is performed rapidly and easily. This treatment is recommended for patients who suffer episodes of symptomatic bradycardia.

This technique can also be useful "in standby" when a case of cardiac arrest or symptomatic bradycardia is anticipated.

The use of this technique during episodes of Ventricular Fibrillation is not recommended.

WARNING: Do not connect the REANIBEX Serie 700 Pacemaker to the electrodes of an internal pacemaker.

1.3 Precautions

WARNING: *Dangerous electrical shock hazard. Do not disassemble the defibrillator as dangerous high voltages can be present. Contact the authorized personnel for any necessary repairs.*

WARNING: *Dangerous electrical shock or fire hazard. Do not immerse either the device or any part of it in water or any other liquid. Avoid spilling liquids on the device or on its accessories. Do not clean the device with flammable agents such as acetones. Do not autoclave the device or use any other sterilization method whatsoever.*

WARNING: *Dangerous electrical shock hazard. The device must be used only by qualified medical personnel who have specific basic training in the following areas:*

- *Cardiac-Pulmonary Resuscitation (CPR)*
- *Utilization of a Defibrillator/Monitor in accordance with the recommendations of the American Heart Association (AHA) or of the European Resuscitation Council (ERC)*
- *Utilization of the REANIBEX Serie 700*

WARNING: *Dangerous electrical shock hazard. The defibrillator delivers up to 200 Joules of electrical energy during shock. Do not touch the patient or the defibrillation electrodes when delivering a shock.*

WARNING: *During defibrillation, stand clear and avoid contact with any part of the patient's body (exposed skin on the head, the body and the extremities) and metal objects such as the bed frame, as these could cause undesirable electrical current paths during defibrillation.*

WARNING: *Air pockets formed between the defibrillation electrodes and the skin of the patient can cause burns during defibrillation. Ensure that the defibrillation electrodes are perfectly adhered to the skin of the patient. Once good skin contact is*

established, if the position of the electrodes must be changed, remove the electrodes and replace them with new ones.

WARNING: Do not allow the defibrillation electrodes to touch each other or to touch any part of conducting material during defibrillation. This contact could produce an electric arc and burns to the patient's skin.

WARNING: Possible damage to the device. Before using the defibrillator, disconnect the patient from all equipment that is defibrillator-protected.

WARNING: Incorrect use of the device can cause injury. Follow the instructions given in the User Manual for its proper use.

DANGER: Explosion hazard. Do not use the device in the presence of concentrated oxygen sources or flammable anaesthetic products.

WARNING: The use of cables, electrodes or batteries manufactured by other manufacturers can result in device malfunction and will make safety certifications null and void. Use only the accessories specified in this manual.

WARNING: The presence of radio frequency (RF) sources near the device can cause equipment malfunction. Electromagnetic compatibility with nearby equipment must be checked before using the REANIBEX Serie 700.

WARNING: Avoid operating the REANIBEX Serie 700 near or on other equipment. If this cannot be avoided, check that the equipment is in proper operating condition before its utilization.

WARNING: The REANIBEX Serie 700 must be installed and put into service according to the information on Electromagnetic Compatibility (EMC) that appears in the section entitled, "A11 – Manufacturer's Guide and Declaration of Electromagnetic Compatibility".

WARNING: El REANIBEX Serie 700 is designed to be used only by qualified medical personnel. The device may cause radio interference or may disrupt the operation of nearby equipment. It may be necessary to take mitigation measures such

as changing the position or location of the REANIBEX Serie 700 or even shielding the area where the device is located.

CAUTION: *Care must be exercised when handling patient cables, including the ECG monitoring equipment when it is used in conjunction with high-frequency surgical equipment.*

FIRE OR SHOCK HAZARD: *Make sure that the accessories and all of the equipment is properly connected. The device or any accessories which are not properly connected together can be a source of ignition or cause an electrical shock.*

CAUTION: *The device can become damaged by mechanical or physical misuse, such as immersion in water or dropping the device from a height of more than 1 m.*

CAUTION: *The components of the device can become damaged if the device is placed near vibration sources.*

WARNING: *The REANIBEX Serie 700 is suitable for use in the presence of high-frequency surgical equipment. Following interference produced by the electrosurgical unit, the equipment returns to its prior operating mode in 10 seconds without losing any stored data. The accuracy of the measurements can be temporarily affected during the use of the electrosurgical unit or defibrillation. This does not affect patient safety or equipment safety. Consult the Instructions for Use for the electrosurgical unit to reduce the risk of burns in case of a defect in this equipment.*

WARNING: *The REANIBEX Serie 700 does not have the capacity to ignore internal pacemaker pulses. The device could detect the internal pacemaker pulses as QRS complexes which results in an indication of an incorrect heart rate. Do not rely on the heart rate indicator displayed by the device with patients who have an internal pacemaker.*

WARNING: *The quality of the ECG signal is affected if the electrical installation connected to the device does not have a ground connection. If this ground connection is not available, connect the equipotential conductor located in the back panel of the device to any metal element accessible in the building structure.*

2. Description of the Device

2.1 Components of the REANIBEX Serie 700

The following section presents a description of the different REANIBEX Serie 700 components, controls, indicators and connectors.

2.1.1 Front view

The elements and indicators that make up the front panel of the device are described below:

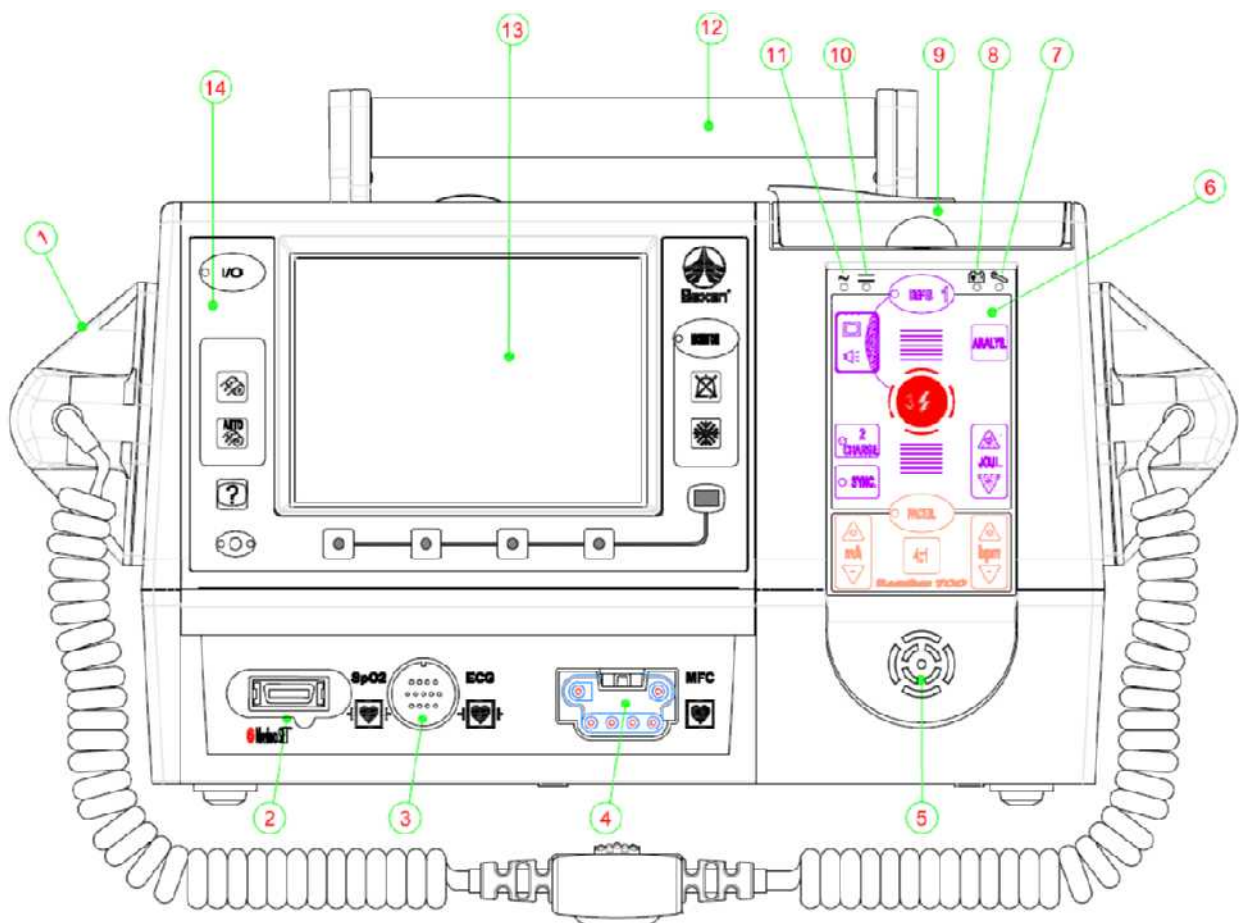

NUMBER	DESCRIPTION
1	REUSABLE EXTERNAL PADDLES
2	The PULSE OXIMETER extension cable CONNECTOR allows the extension cable to be connected to the pulse oximetry sensor.
3	PATIENT CABLE CONNECTOR. It allows the patient cable to be connected which can be 4, 5 or 10 leads.
4	MULTIFUNCTION CONNECTOR. It connects the reusable external or internal paddles, and the single-use multifunction electrodes.
5	The high-fidelity SPEAKER system provides the sounds that indicate an alarm, QRS detection, exceptional conditions that occur during the utilization and also audible messages that guide the user during his actions (Only for the devices that have the Semi-Automatic Defibrillator option).
6	The FRONT PANEL which includes the activation keys for the different operating modes.
7	MALFUNCTION INDICATOR. It is illuminated when the device detects an error during any of the self-tests.
8	The BATTERY STATUS INDICATOR is an icon with a light. If this indicator light is green it means the battery is charging and if it is red it indicates LOW battery
9	Protective RECORDER COVER. The device recorder is located under this protective cover.
10	DIRECT CURRENT INDICATOR. It indicates that the device is connected to a DC external power supply source (car battery)
11	ALTERNATING CURRENT INDICATOR. It indicates that the device is connected to an AC external power supply source (AC mains)
12	CARRYING HANDLE. This is a folding handle that allows simple means of transport for the device.
13	Device SCREEN. This is a graphic display with 320 x 240 dot resolution. The device has two types of optional screens: High-resolution TFT and graphic LCD.
14	The FRONT PANEL includes the activation keys of the different operating modes and keys that are common to all operating modes.

2.1.2 Overhead view

The elements that can be seen in the top part of the REANIBEX Serie 700:

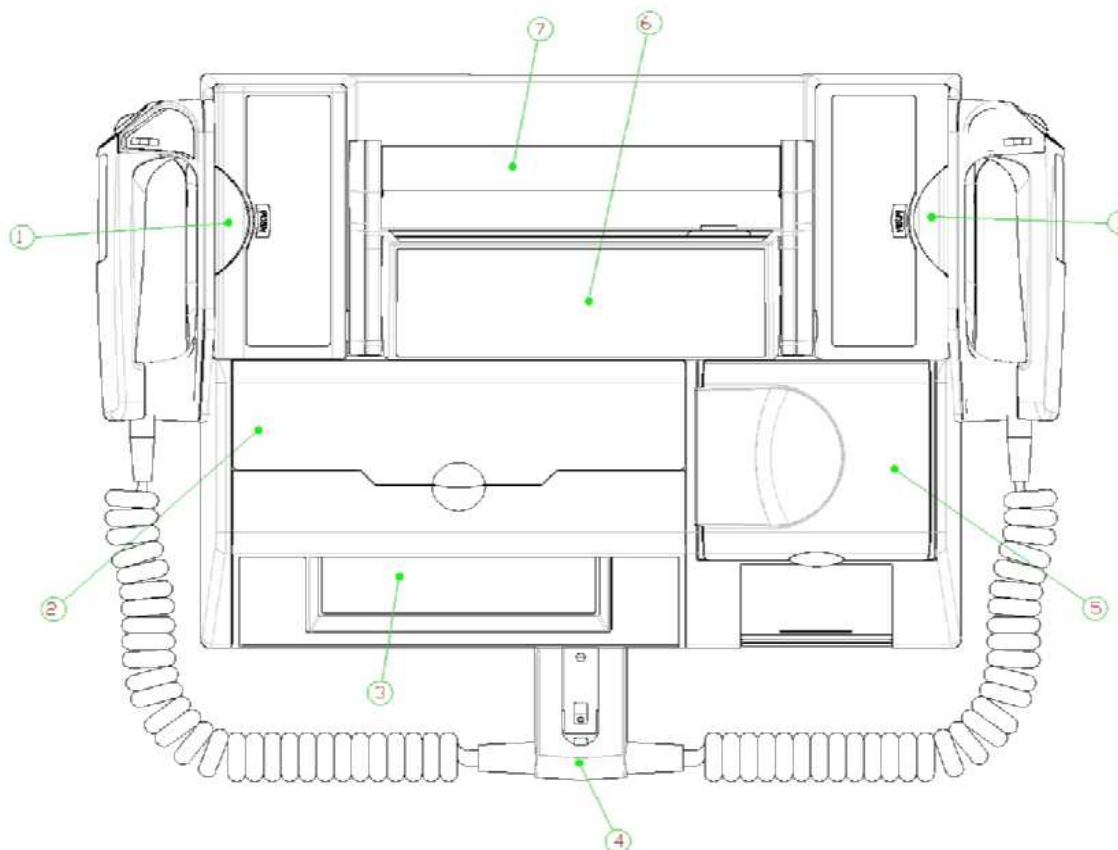

NUMBER	DESCRIPTION
1	HOLDER of the reusable external paddles. To release the paddles, press the holder and extract the paddles
2	Protective COVER of the COMPACT FLASH memory card. The memory card holder is housed under this protective cover, Only the devices that have the Semi-Automatic Defibrillator option have the option of data recording in the Compact Flash.
3	Device SCREEN .
4	CONNECTOR for the Reusable external Paddles.
5	Protective RECORDER COVER .
6	Basic INSTRUCTIONS for use of the REANIBEX Serie 700.

7 CARRYING HANDLE.

2.1.3 Rear view

The rear panel of the REANIBEX Serie 700 presents the following elements:

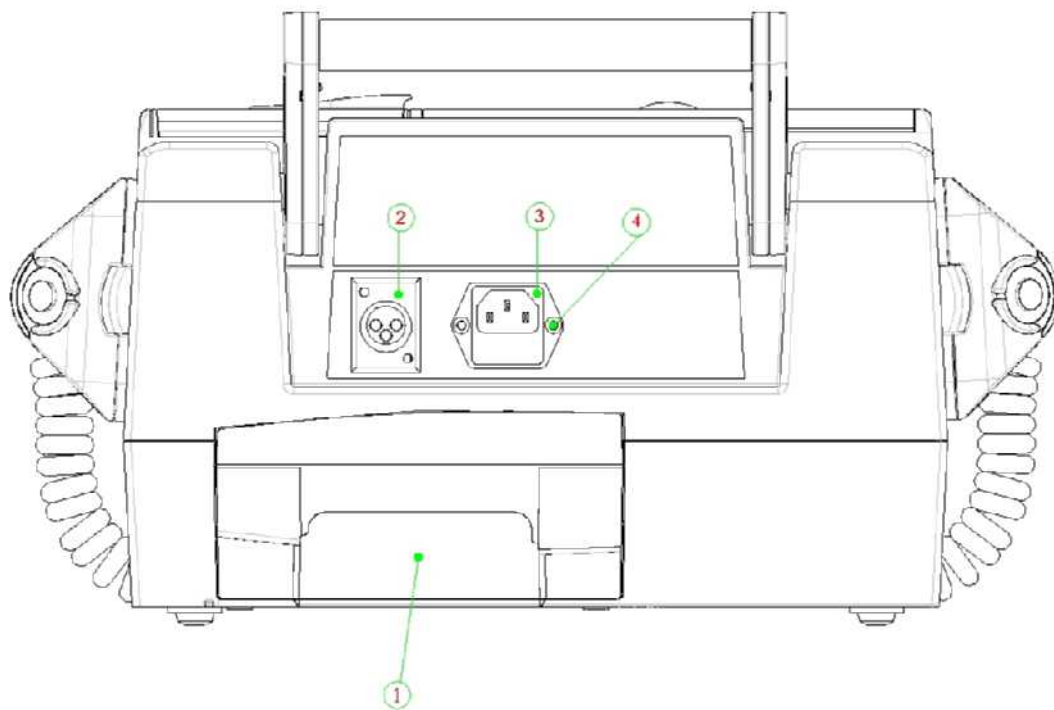

NUMBER	DESCRIPTION
1	BATTERY HOUSING. The place where the device’s battery is housed.
2	CAR BATTERY CONNECTOR. It enables the device to be connected to a D.C. external power supply
3	AC POWER CONNECTOR. It allows the connection of the device to a A.C. external power supply
4	EQUIPOTENTIAL CONDUCTOR. It provides an additional connection to the ground connection of a building electrical installation.

2.2 Front panel

This section describes the functions associated with each of the keys available on the front panel. The different keys are grouped according to their operating mode.

There are a series of keys which are common to all operating modes:

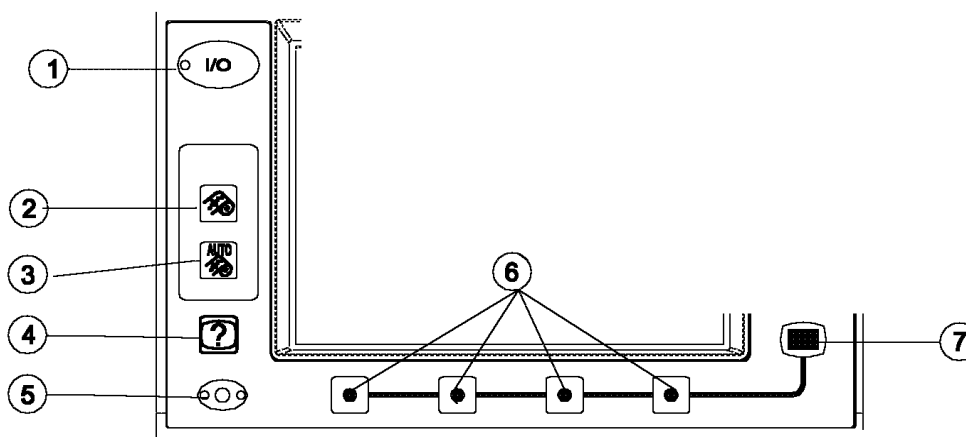

NUMBER	DESCRIPTION
1	GREEN main on/off (I/O) key of the device. The indicator of this key is illuminated when the device is switched on.
2	RECORDER start/stop key. It starts the recording of both the ECG signal and the events which occurred during the operation.
3	AUTOMATIC RECORD key for all the leads. It allows all the leads to be recorded depending upon the available patient cable.
4	EVENTS Key. It allows an event from a predetermined list to be included in the actions.
5	MICROPHONE . It allows the audio recording of the surrounding setting that unfolds during the utilization (only for devices that have this option and are operating in Semi-Automatic Defibrillator mode)
6	FUNCTION KEYS . Their function changes depending upon the operating mode
7	MENU Key. It allows access to the different available configuration options in the various operating modes.

2.2.1 Monitor Mode

The keys corresponding to the Monitor mode are described below:

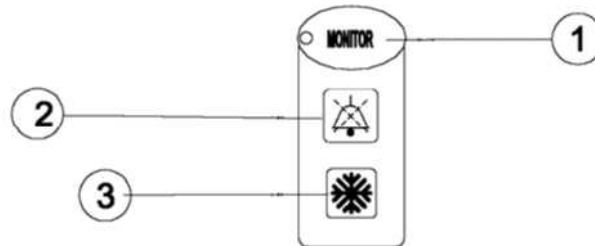

NUMBER	DESCRIPTION
1	MONITOR mode access key. The indicator of this key is illuminated when the device is operating in Monitor mode.
2	SUSPENDED SOUND ALARM Key. It allows sound alarm indicators to be deactivated for a maximum of 2 minutes. If a new alarm occurs while the sound alarm indicator is suspended, the sound alarm indicator will be automatically reactivated.
3	FREEZE Key. It allows the ECG signal to be frozen on-screen. While the signal is frozen, a small window appears at the top of the screen with the temporary progression of the ECG signal.

2.2.2 Defibrillator Mode

The keys that correspond to the Defibrillator operating mode that are located on the front panel of the device are:

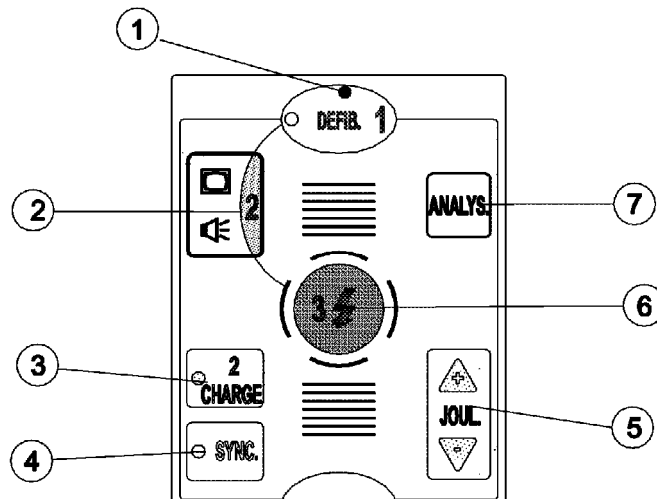

NUMBER	DESCRIPTION
1	DEFIBRILLATOR mode access key. The indicator of this key is illuminated when the device is operating in Defibrillator mode.
2	Indicator to follow audible and visual instructions of the device when it operates in Semi-Automatic Defibrillator mode.
3	CHARGE key for the selected energy level. The indicator of this key is illuminated when the energy has finished charging. It can only be activated in Manual Defibrillator mode.
4	ACTIVATION/DEACTIVATION key for SYNCHRONIZED shock. When this option is active, the indicator of this key is illuminated. This option is active only in Manual Defibrillator mode.
5	SELECT ENERGY Keys. They allow the energy level for discharge to be selected. This key is active only in Manual Defibrillator mode.
6	SHOCK button. This button illuminates when the device is ready to deliver a shock, and allows the defibrillation shock to be delivered to the patient. It is only active when using single-use multifunction electrodes or internal paddles.
7	ANALYSIS Key. It allows access to the Semi-Automatic Defibrillator mode or to start an analysis during CPR. This key only appears in those devices that have the Semi-Automatic Defibrillator option.

2.2.3 Pacemaker Mode (Optional)

The following keys located on the front panel of the REANIBEX Serie 700 allow it to operate in the Pacemaker mode:

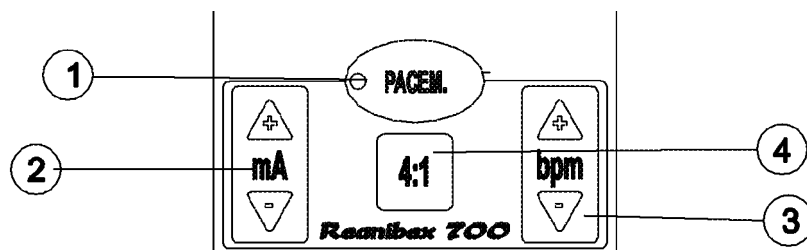

NUMBER	DESCRIPTION
--------	-------------

1	PACEMAKER mode access key. The indicator of this key is illuminated when the device is operating in Pacemaker mode.
2	SELECT AMPLITUDE key to choose the correct amplitude for pacemaker stimulation pulses
3	SELECT RATE key to choose the pacemaker stimulation rate
4	4:1 key. While holding this key pressed down, the pacemaker stimulation rate is divided by 4 in order to be able to observe the intrinsic rhythm of the patient.

2.3 Screen

The REANIBEX Serie 700 has a high-resolution LCD graphic display with 320x240 pixels (1/4 VGA) where both the ECG signal and the pleth waveform (SpO2) (optional) are displayed as well as the information relating to the patient monitoring parameters and the status of the device. The device comes with the option of a wide-angle TFT screen.

The screen of the device subdivides into three well differentiated parts:

1. **Top part** - Displays the operating parameters of the device (real-time clock, information through the use of icons on battery status, equipment status, electrodes off, cancel sound alarms, etc.), numerical values on the monitoring parameters (Heart Rate and SpO2%) and icons which indicate exceptional operating conditions (recording errors, Compact Flash Memory Card errors, etc.).
2. **Middle part** – Displays the biological signals. It can display a single ECG channel or cascaded, or an ECG channel in conjunction with the pleth waveform for devices that have this option available.

The ECG signal displayed on-screen is used to obtain the heart rate, to synchronize energy shock delivery and to analyse heart rhythms in the Semi-Automatic Defibrillator mode.

The lower section of this area also displays user guide messages when in Semi-Automatic Defibrillator mode and informative messages for the rest of the modes.

3. **Lower part** - Displays the connotation that is attributed to each of the function keys that are located under the screen.

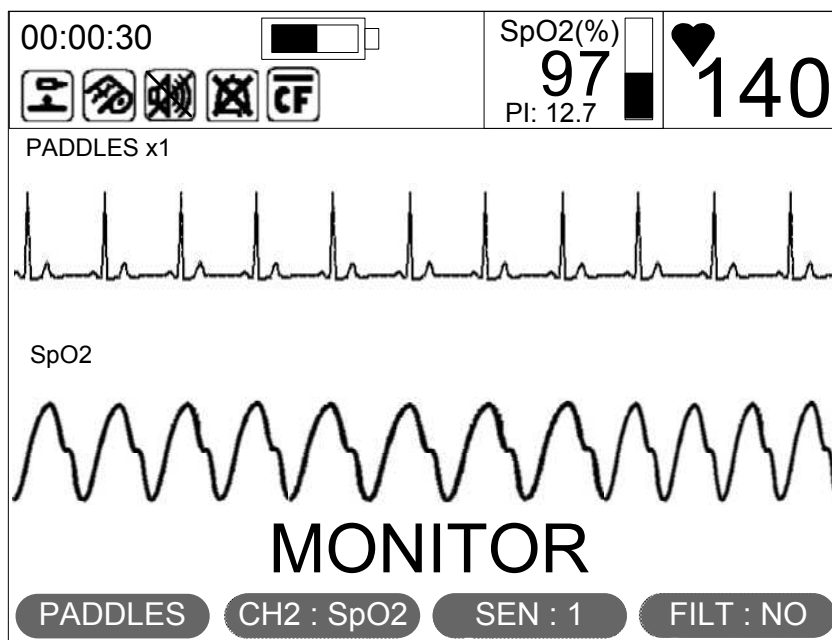

2.4 Paddles, Electrodes and Patient Cables

For monitoring purposes, the REANIBEX Serie 700 can use patient's cable, reusable external or internal paddles and single-use multifunction electrodes. For defibrillation, reusable external or internal paddles and single-use multifunction electrodes can be used.

The device can be used with a 4, 5 or 10 lead patient cable. The device automatically detects the type of cable connected which allows the different leads to be viewed.

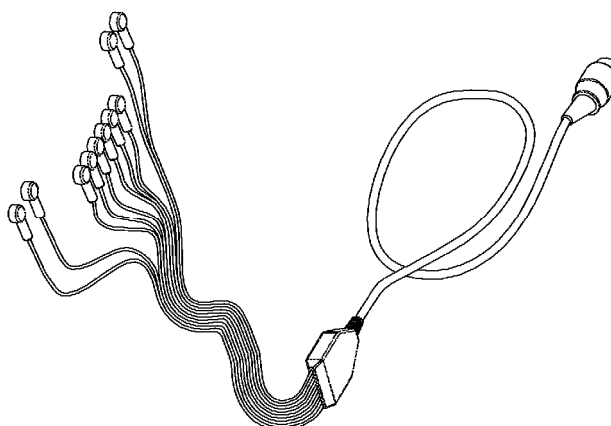

The reusable external paddles have keys for energy selection and charging, for printing, and two shock push buttons:

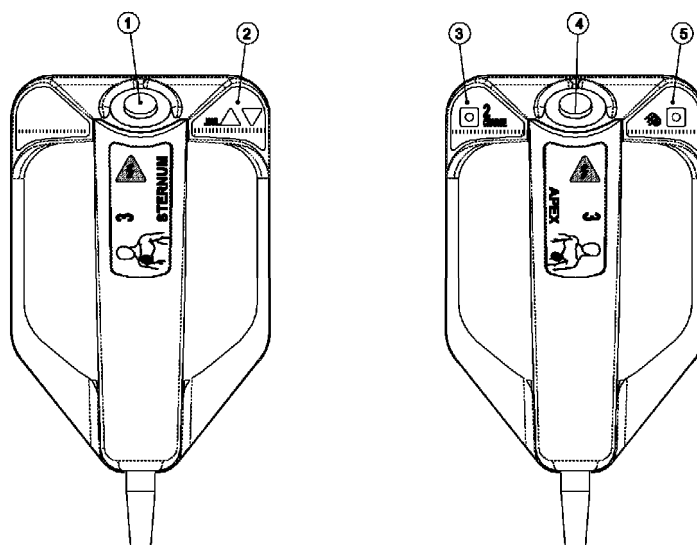

NUMBER	DESCRIPTION
1	SHOCK Push Button on the Sternum paddle. Operating in Manual Defibrillator mode allows the shock to be delivered to the patient when pushed simultaneously with the shock push button on the Apex paddle.
2	SELECT ENERGY Keys. They allow the energy discharge level to be set when operating in Manual Defibrillator mode.
3	CHARGE Key. Operating in Manual Defibrillator mode allows the energy discharge level to be charged.
4	SHOCK Push Button on the Apex paddle. Operating in Manual Defibrillator mode allows the shock to be delivered to the patient when pushed simultaneously with the shock push button on the Sternum paddle.
5	PRINT Key. It allows both the biological signals and the events to be recorded that occur with the device during the utilization.

The device can use two types of different single-use multifunction electrodes:

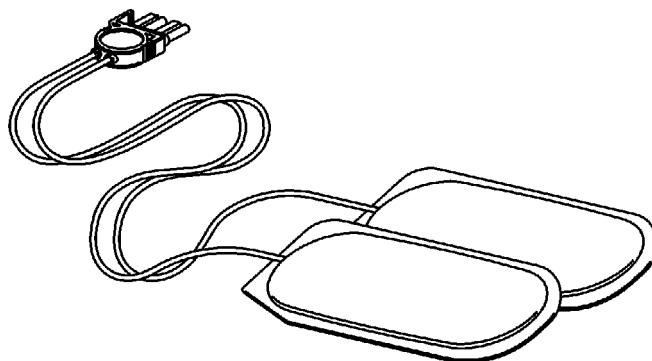

Single-use electrode-cables

WARNING: The device provides defibrillation-protected features only if the 4, 5 or 10 lead patient cable is used

2.5 Battery

The REANIBEX Serie 700 uses rechargeable high-capacity NiMH batteries that require minimal maintenance.

The duration of these batteries depends upon how often they are used and their actual usage. When used and maintained correctly the service life of the battery is 5 years or 500 charge/shock cycles.

For more information about the battery consult section "13.6 Battery".





WARNING: Use only batteries supplied by OSATU or by its authorized distributors. The use of another type of battery can cause device malfunction.

2.6 Events

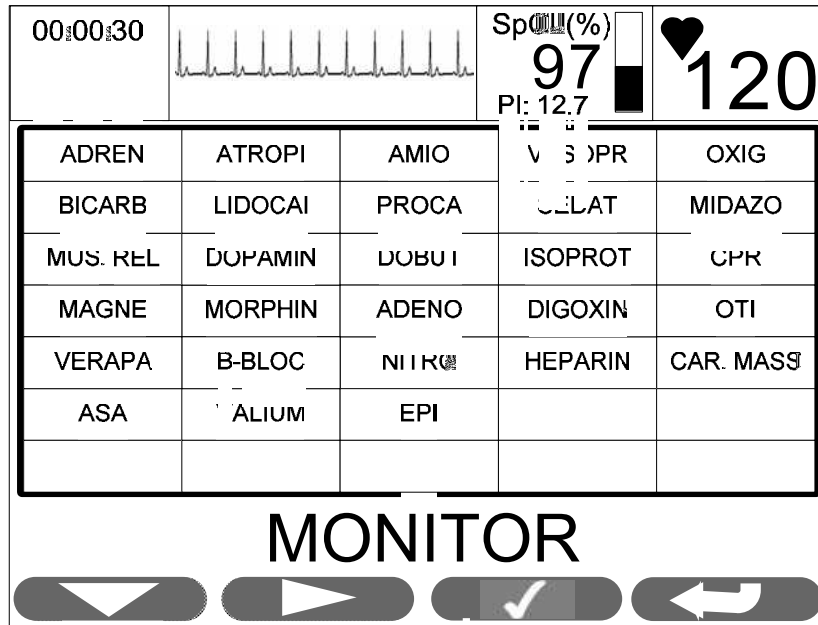
The REANIBEX Serie 700 offers the user the option to include a series of predefined incidents called EVENTS. To use this option, there is a key called EVENTS  on the front panel.

This key is active in any of the operating modes and when it is pushed, a screen appears with the following information:



The  and  keys allow the user to navigate the available options on the table, whereas the  key enters the event. To exit this option, use the  key.

In the utilization performance report, the event will be displayed along with the time. In addition, within the information recorded in the Compact Flash Memory Card, the event will be recorded in the EGG signal recording as well as recording the 8 seconds prior to and following this event.

NOTE: For more information about the meaning of the events, see "ANNEX "A6. Device Events"

2.7 Menu Options

Specific parameters can be configured during the utilization of the different REANIBEX Serie 700 operating modes. The MENU  key on the front panel allows access to the options. The function keys located under the screen acquire a function that changes depending upon the operating mode being used:

1. Monitor Mode

The options that appear on the function keys for this mode allow changes to be made in the alarm settings, the recording options and the user interface. The report and trends can also be viewed.

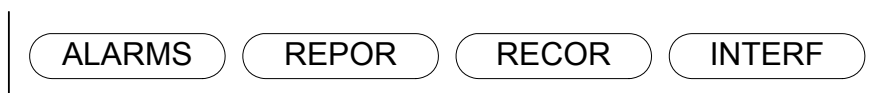

2. Manual Defibrillator Mode

The options that appear on the function keys for this mode allow changes to be made in the alarm settings, the recording options, the user interface:



3. Semi-Automatic Defibrillator and Pacemaker Modes

The options that appear for these modes only allow changes to be made in the recording and user interface options:



2.7.1 Alarms Menu

By pressing the  key, the screen allows the user to set the different alarm limits available in the device:

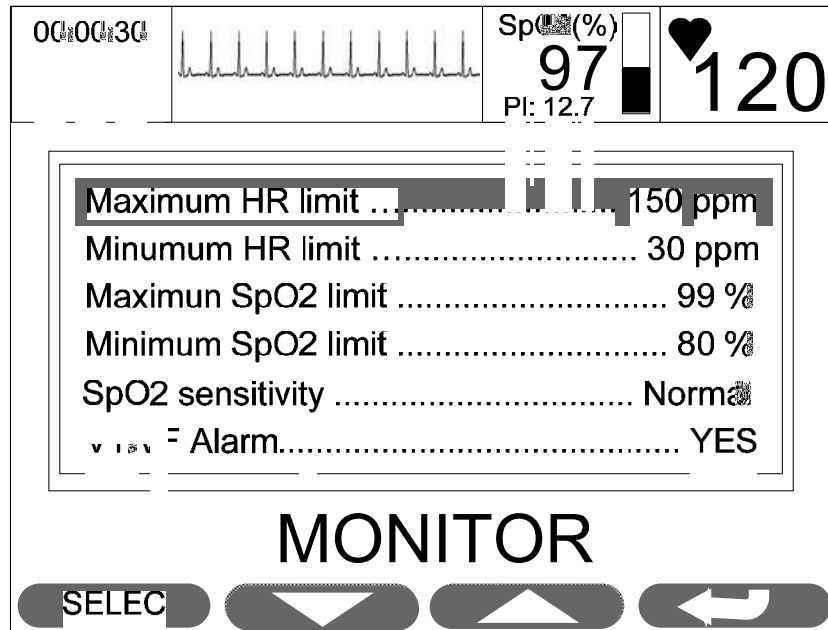



For more information about changing the alarm settings, consult section "4.6 Alarms".

2.7.2 Report Menu

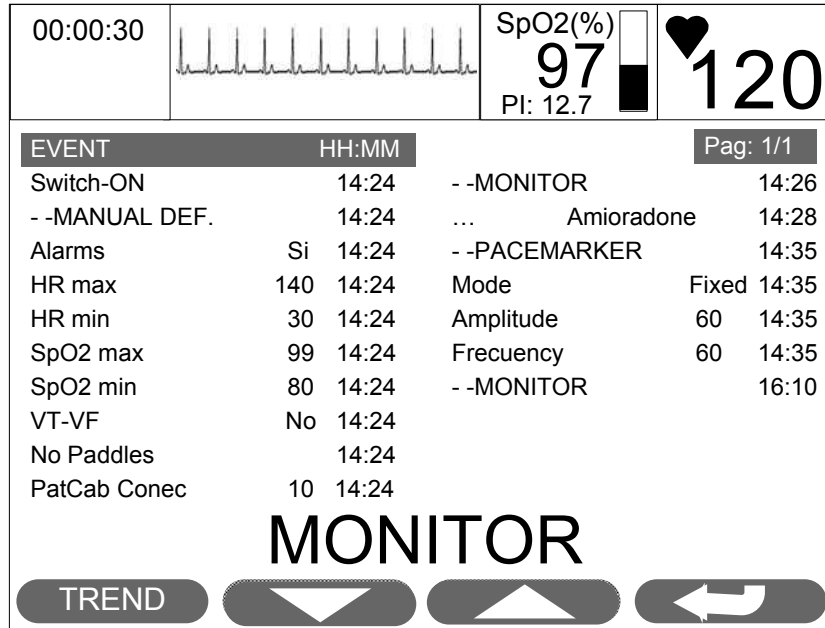
Pressing the **REPOR** key accesses the screen that displays the utilization performance report.



In the top part of the screen, the number of pages (screens) in the report is displayed. The different pages can be viewed using the  and  keys.

From this screen, pressing the  key gives access to the graph displaying the Heart Rate (HR) and pulse oximetry (SpO2%) trends (for devices with this option).

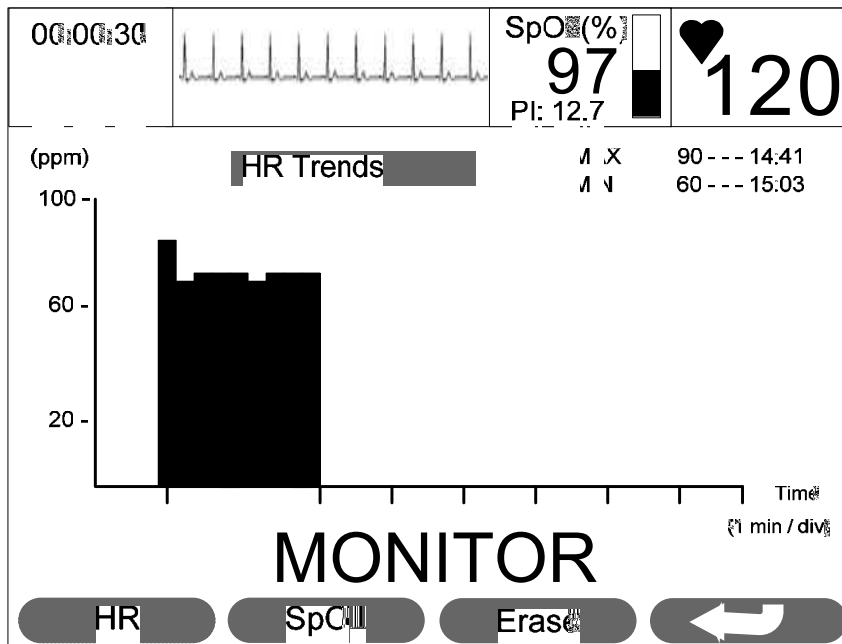

Within the trends screen, if the **HR** key is pressed the Heart Rate trend will appear on-screen from start-up up to the present. In the top part, the maximum and minimum HR values are displayed that were recorded during this interval, along with the time they occurred.

For devices that have the pulse oximetry option, when the **SpO2** key is pressed, a similar screen appears but it displays the recorded pulse oximetry (% SpO2) values.

While viewing both, the report and the trends, the information will be continuously updated, in such a way that if an event/incidence occurs or if new HR and % SpO2 values are recorded, the information will be updated.

The **Cancel** key will eliminate the trends and the utilization performance report.

2.7.3 Recorder Menu

By pressing the **RECOR** key, the function keys located below the screen allow changes to be made in the recorder parameters:

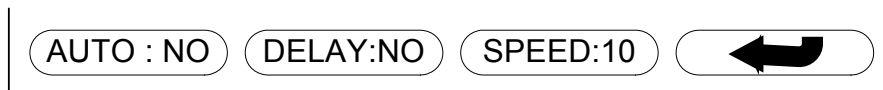

The **AUTO:NO** key allows the user to configure the automatic printing mode of the recorder, the **DELAY:NO** key configures whether or not delayed printing is required and the **SPEED:10** key selects the printing speed. Press the corresponding key to change the parameters.



To exit this menu and return to the previous menu, use the  key.

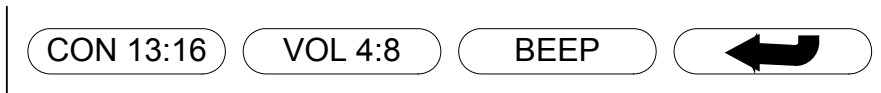

For more information about the recorder, consult Section "11.5.1.5 Recorder"

2.7.4 Interface Menu

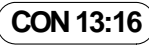
When the  key is pressed, changes can be made to the settings for the user interface:



The  key allows the contrast settings to be set for the device's screen. By using the  key, both the volume and the beeps emitted for messages can be adjusted (only for devices that have this option). In both cases the first number that appears on this key indicates the level selected whereas the second number indicates the levels available. Press the key until obtaining the desired parameter level.

The  key enables the QRS beep to be activated/deactivated. When the beep is disabled, the  icon appears in the top of the screen to confirm the deactivation.

To exit this menu and return to the previous menu, use the  key.

3. Installation of the Device

3.1 General

Before using the REANIBEX Serie 700, make sure that the device is ready for use. To do so, perform the following checks:

- Make sure that the device is in perfect condition. Check that both the device and its accessories and cables do not show any signs of damage, and that they are in good condition.
- Check the battery status. Turn the device on and check the battery status indicator located in the upper part of the device screen, as well as the battery status indicator located in the front cover of the device. If the indicator remains illuminated and red, it indicates that the battery charge is low.

WARNING: Use only batteries supplied by OSATU or by its authorized distributors. The use of another type of battery can cause device malfunction.

- Make sure that the defibrillation and the monitoring electrodes are stored under perfect conditions. Check their expiry date as well.

WARNING: Follow the instructions given on the labels of the defibrillation and monitoring electrodes carefully.

WARNING: Both the defibrillation electrodes and the monitoring electrodes must be used before the expiry date indicated on their label. If the electrodes have dried up or are damaged they can cause electric arcs and burns during their use.

WARNING: Dispose of both the defibrillation and monitoring electrodes once they have been used.

- Always keep the following replacement items at hand:
 - A spare battery, in a good state of maintenance.
 - Spare defibrillation and monitoring electrodes.
 - Accessories for cleaning and shaving the areas where the electrodes are to be positioned on the patient, if necessary.

3.2 Cables

The REANIBEX Serie 700 has the option of using the 4, 5 and 10 lead patient cable for monitoring the ECG signal which automatically detects the connected cable. The ECG signal can also be monitored by using reusable external and internal paddles or single-use multifunction electrodes.

Connection of the patient cable is carried out as is indicated in the following figure:

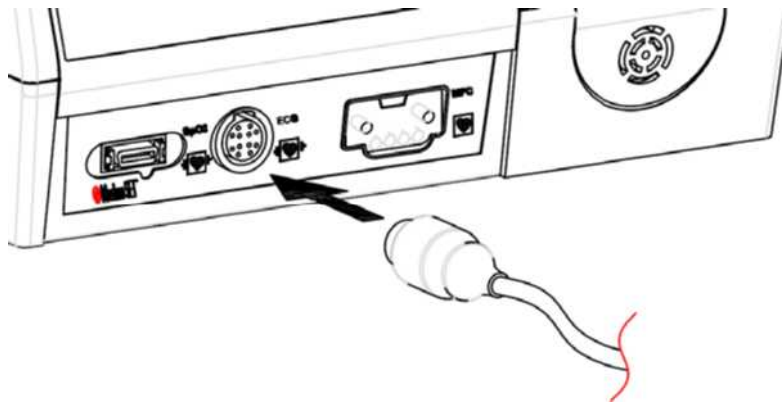

For defibrillation, the device provides the option of connecting reusable internal or external paddles or single-use multifunction electrodes. All of them are connected in the multifunction connector (MFC) located on the front panel of the device:

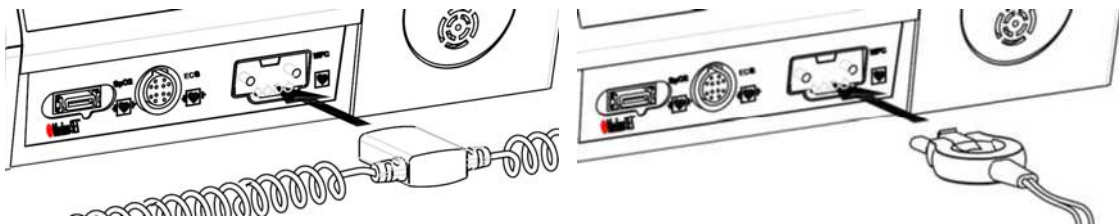

The device also has the option of a pulse oximetry module. The connection of this cable to the device is made via the connector on the front panel of the device as indicated in the figure:

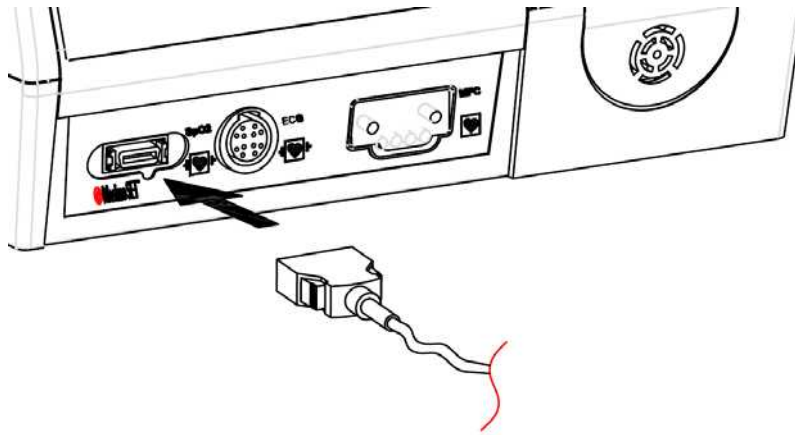

3.3 Battery

The REANIBEX Serie 700 uses high-capacity rechargeable NiMH batteries that require minimal maintenance. The battery compartment is located in the rear of the device so that access is rapid and simple.

To install the battery, align it with the compartment located in the rear of the device and introduce the battery into the device until a “click” is heard which indicates that the battery has been correctly inserted.

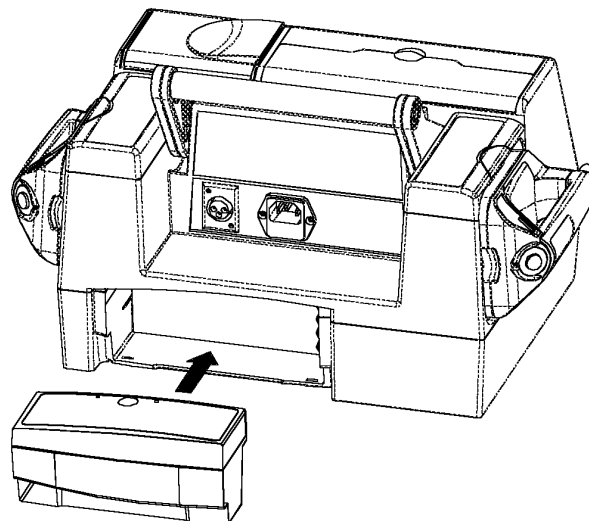

When the battery is installed in the device and connected to an external power supply (AC mains or car battery), the device continuously charges the battery, using an internal charger.

To extract the battery, pull the device's battery lock latch (black-coloured) upwards and holding it in this position, extract the battery from its compartment.

3.4 Recorder (Optional)

The REANIBEX Serie 700 recorder is located in its upper part. To install paper in the recorder, perform the following steps:

1. Open the cover of the device where the recorder is located
2. Open the door of the recorder pressing its safety catch as shown in the figure.

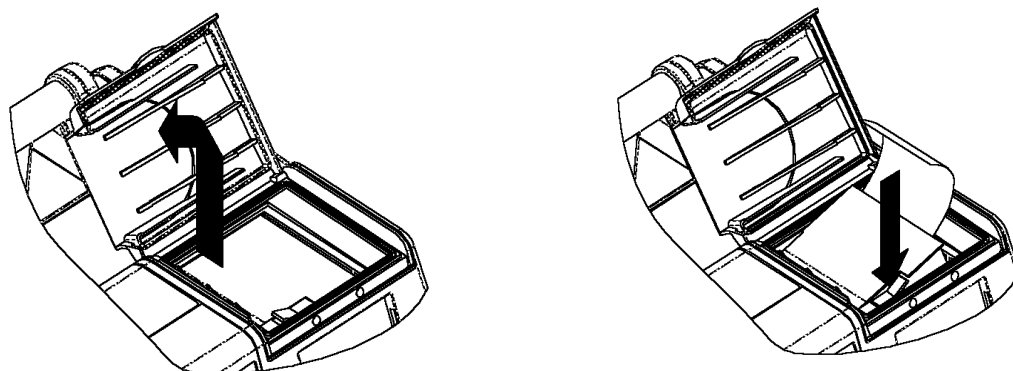

3. If there is an empty roll of paper or a roll that needs to be replaced, remove it by pulling it upwards.
4. Insert the new roll of paper, so that the end of the paper is towards the right side and the grid pattern is downwards.
5. Pull the end of the paper out a few centimeters in such a way that, on closing the door of the recorder and the cover of the device, the paper projects towards the left side of the device.

3.5 Compact Flash Memory Card (Optional)

The REANIBEX Serie 700 offers the option of a Compact Flash memory card, in which information is stored relating to the actions performed with the device.

The insertion and removal of this Compact card must always be carried out with the device switched off in order to avoid loss of information.

To insert the memory card in the device:

- 1- After switching the device off, open the top cover of the device located just above its screen.
- 2- Insert the memory card with the portion that contains the name and indicating arrow towards the front. The arrow must point downwards.
- 3- Press until the mechanism located on the right side of the card projects from the device.
- 4- Close the top cover of the device.

To remove the card from the device:

- 1- After switching the device off, open the top cover of the device located just above the screen.
- 2- Press the mechanism located to the right of the Compact Flash card until the latter projects from the device.
- 3- Remove the card and close the cover of the device.

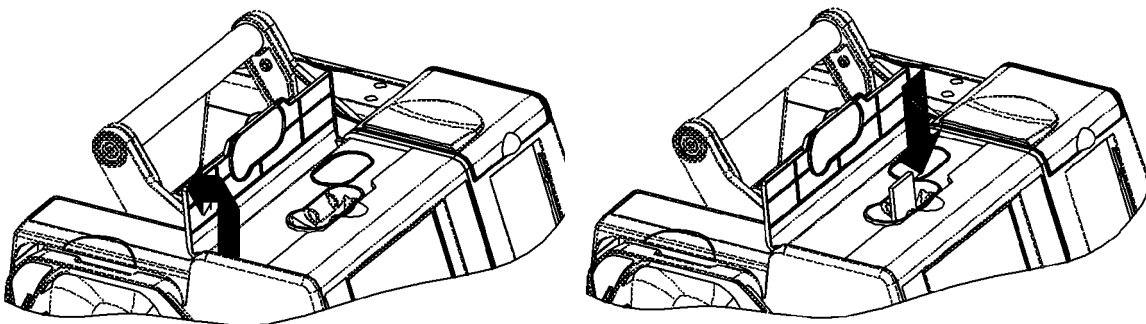

WARNING: Insert and remove the Compact Flash memory card only when the device is switched off. If the Compact Flash card is inserted with the device switched on, the data will not be recorded, whereas if the Compact Flash card is removed with the device switched on, the information about the current utilization will be lost.

Blank sheet

4. Monitoring

4.1 Description

In this section, the basic functions of the REANIBEX Serie 700, operating in Monitor mode, are described.

The REANIBEX Serie 700 can be used for monitoring the ECG signal and arrhythmias using the 4, 5 or 10 lead patient cable, the external reusable paddles or the single-use multifunction electrodes.

To access the Monitor mode, press the  key on the front panel. The key indicator will be illuminated, indicating that it is in Monitor mode. The screen that appears when this mode is accessed is as follows:

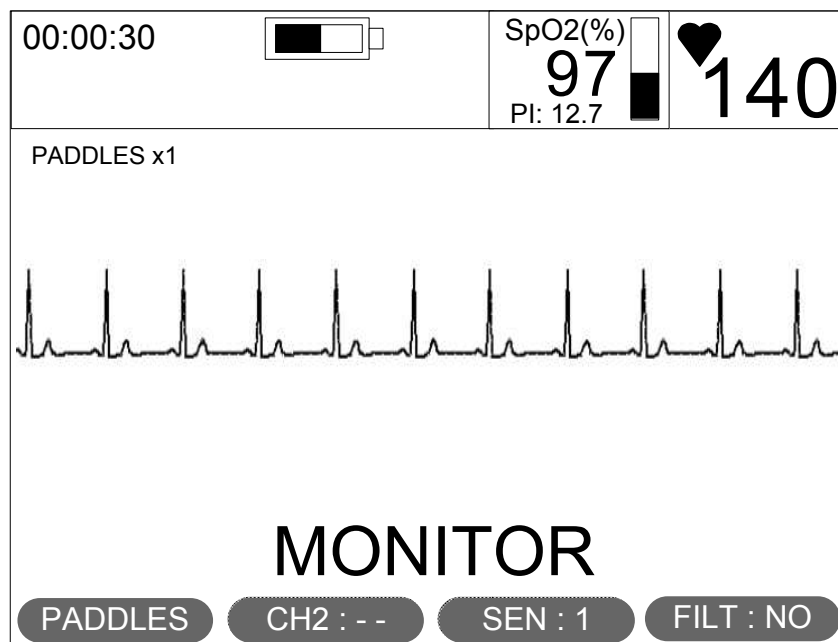

When the patient cable and the paddles or the single-use multifunction electrodes are connected to the device, the device allows a patient cable lead or a paddle lead or multifunction single-use electrodes lead to be selected.

4.2 Warnings

WARNING: *Possible incorrect interpretation of the ECG data. The monitor screen is indicated solely for the identification of the basic ECG rhythm since it does not have the resolution required to make a diagnosis. To make any diagnosis or interpretation, print out the ECG signal.*

WARNING: *The REANIBEX Serie 700 does not have the capacity to reject internal pacemaker pulses. The device could detect the internal pacemaker pulses as QRS complexes which results in an indication of an incorrect heart rate. Do not rely on the heart rate indicator displayed by the device with patients who have an internal pacemaker.*

WARNING: *Make sure that when connecting and disconnecting the electrodes from the patient's skin, they do not come in contact with any conducting materials.*

4.3 ECG Monitoring Procedure

The monitoring function of the REANIBEX Serie 700 can be performed using either, the patient cable, internal or external reusable paddles and single-use multifunction electrodes.

The REANIBEX Serie 700 automatically detects the type of patient cable that has been connected (4, 5, or 10 lead). In addition, it is able to distinguish if in the multifunction connector (MFC) is connected to the single-use multifunction electrodes and external or internal paddles.

4.3.1 Use of paddles and single-use multifunction electrodes

To monitor the ECG using paddles or single-use multifunction electrodes, follow the steps below:

1. Connect the paddles or electrode cable to the multifunction connector (MFC) of the REANIBEX Serie 700 as shown in the following figures:

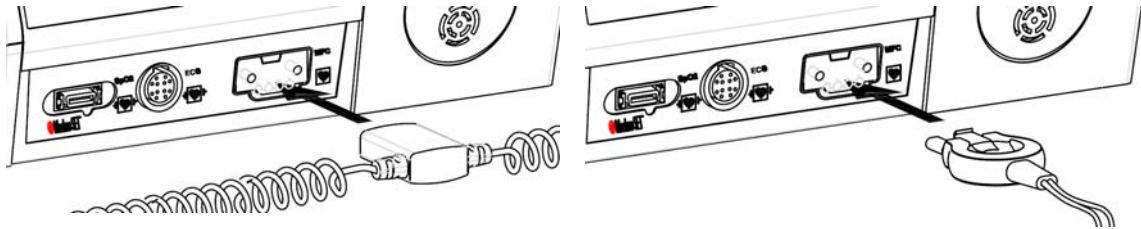

2. Prep the patient's skin in the places where it will be necessary to connect the electrodes or the paddles:
 - Remove chest hair from the patient if necessary. Avoid scraping or cutting the patient's skin. Avoid placing the electrodes or the paddles on broken or irritated skin.
 - Thoroughly clean and dry the patient's skin. Do not ever use either pure alcohol or ether to clean the patient's skin, since these products increase skin resistance.
3. Position the electrodes or the paddles in the anterior-lateral position.

When using single-use multifunction electrodes, make sure that the seal on the single-use multifunction electrode packet is perfectly intact and that the expiry date is still valid.
4. Select the PADDLES lead for viewing the signal obtained using the single-use electrodes or paddles.

Take into account the following special considerations when placing both the electrodes and the paddles:

- **Obese patients or patients with large breasts.** Apply the electrodes or the paddles on a flat surface of the torso.
- **Thin patients.** Press the electrodes on the torso following the contour of the ribs to avoid air cavities.
- **Patients with implanted pacemakers.** Position the electrodes or the defibrillation paddles at least 10 cm from the generator and continue with the same procedure protocol as for any other patient with a cardiac arrest.
- **Patients with implanted defibrillators.** Position the electrodes or the defibrillation paddles at least 12-15 cm from the generator, and continue with the same procedure protocol as for any other patient with a cardiac arrest.

WARNING: *If monitoring is carried out for prolonged periods of time, it may be necessary to periodically change the single-use multifunction electrodes. Consult the documentation on single-use multifunction electrodes in order to change them.*

4.3.2 Use of patient cable

The monitoring of the ECG signal, using the patient cable can be performed using a 4, 5 and 10 lead cable. Follow the steps below to monitor the ECG signal using the patient cable.

1. Connect the patient cable to the connector of the REANIBEX Serie 700 as shown in the following figure.

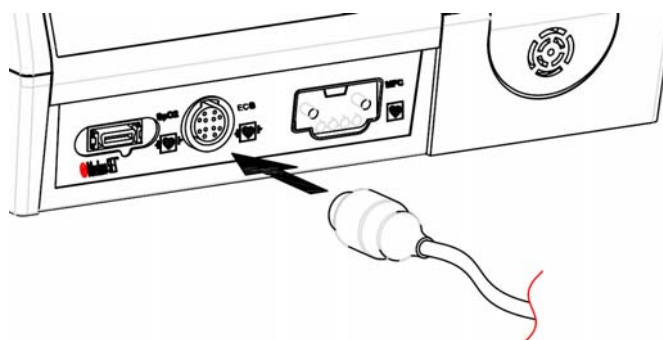

2. Prep the patient's skin in the places where the monitoring electrodes will be positioned.
 - Remove chest hair from the patient if necessary. Avoid scraping or cutting the patient's skin. Avoid placing the electrodes or the paddles on broken or irritated skin.
 - Thoroughly clean and dry the patient's skin. Do not ever use either pure alcohol or ether to clean the patient's skin, since these products increase skin resistance.
3. Position the monitoring electrodes and connect them to the patient cable. Make sure that the seal of the monitoring electrode pack is perfectly intact and that the expiry date is still valid.
4. Select the desired lead that will be viewed.

WARNING: *If monitoring is carried out for prolonged periods of time it may be necessary to periodically change the monitoring electrodes. Consult the documentation on monitoring electrodes in order to change them.*

Take into account the following guidelines during the use of the electro-surgical unit to minimize interference from the electro-surgical equipment and to provide maximum security for the patient and the user:

- Keep all patient monitoring cables off the ground and away from blades and electro-surgical unit return cables.
- Make sure that the grounding pad of the electro-surgical unit is properly placed on the patient.

WARNING: To prevent burns due to the electro-surgical unit in monitoring areas, make sure that the electro-surgical unit's return circuit is properly connected so that the return pathways cannot travel through the monitoring electrodes.

4.3.3 Positioning the monitoring electrodes

For the correct positioning of the monitoring electrodes, the following figure should be taken into account which shows the positioning of all the monitoring electrodes depending upon the patient cable available in the device.

If monitoring is carried out with six precordial leads, it is important to locate the fourth intercostal space since this landmark serves as reference for positioning the rest of the precordial leads. To locate this landmark:

1. Place the finger in the depression of the superior part of the sternum.
2. Go downwards until locating a small bony protuberance (Angle of Louis), which is where the manubrium joins the body of the Sternum.
3. Locate the second intercostal space on the right side of the patient just below the angle of Louis.
4. Move downwards another two intercostal spaces until locating the fourth, which is the position of the V1/C1 lead.

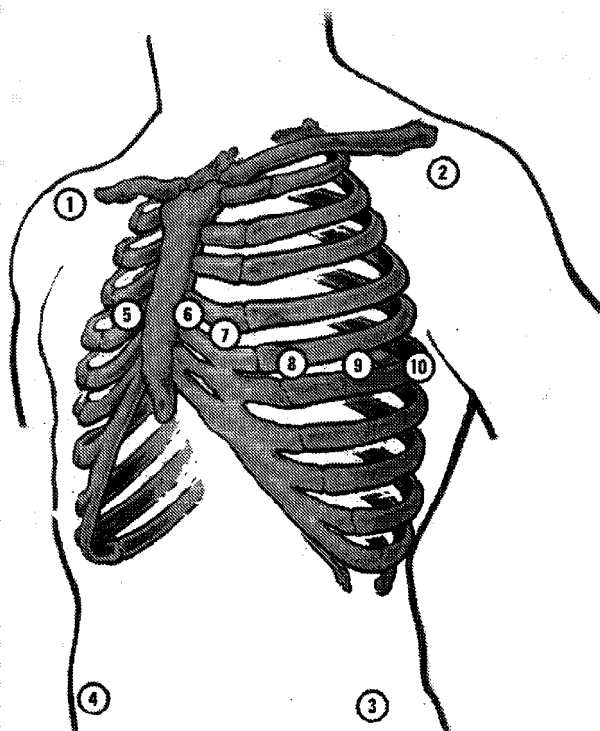

- **4 Lead Patient Cable**

- 1- *Position of RA/R (White/Red)* - Near the right shoulder and below the clavicle.
- 2- *Position of LA/L (Black/Yellow)* - Near the left shoulder and below the clavicle.
- 3- *Position of LL/F (Red/Green)* - On the lower left part of the abdomen.
- 4- *Position of RL/N (Green/Black)* - On the lower right part of the abdomen.

- **5 Lead Patient Cable**

- 1- *Position of RA/R (White/Red)* - Near the right shoulder and below the clavicle.
- 2- *Position of LA/L (Black/Yellow)* - Near the left shoulder and below the clavicle.
- 3- *Position of LL/F (Red/Green)* - On the lower left part of the abdomen.
- 4- *Position of RL/N (Green/Black)* - On the lower right part of the abdomen
- 5- *Position of V/C (Brown/White)* - On the thorax, depending upon the required lead.

- **10 Lead Patient Cable**

- 1- *Position of RA/R (White/Red)* - Near the right shoulder and below the clavicle or on the right arm.

- 2- **Position of LA/L (Black/Yellow)** - Near the left shoulder and below the clavicle or on the left arm.
- 3- **Position of LL/F (Red/Green)** - On the lower left part of the abdomen or on the left leg.
- 4- **Position of RL/N (Green/Black)** - On the lower right part of the abdomen or on the right leg.
- 5- **Position of VI/C1** - The fourth intercostal space, on the external right edge.
- 6- **Position of V2/C2** - The fourth intercostal space, on the external left edge.
- 7- **Position of V3/C3** - At half the distance between V2 and V4.
- 8- **Position of V4/C4** - Fifth intercostal space, on the left mid clavicular line.
- 9- **Position of V5/C5** - At the same level as V4 on the anterior axillary line.
- 10- **Position of V6/C6** - At the same level as V4 on the left mid axillary line.

4.4 Selecting the size and the lead

In order to accurately detect the potential patient pathologies, it is important to choose the appropriate lead and its size.

The number of leads that can be viewed depends upon the type of patient cable connected. The leads that can be viewed for the different patient cables are indicated below.

- 4 lead patient cable: I, II, III, aVR, aVL and aVF
- 5 lead patient cable: I, II, III, aVR, aVL, aVF and V
- 10 lead patient cable: I, II, III, aVR, aVL, aVF, V1, V2, V3, V4, V5 and V6

The selection of the lead to be viewed is made by using the **PADDLES** key located below the screen of the device. The selected lead is viewed both on-screen beside the waveform, and in the key that allows the selection of the lead. To select the required lead, press the key until obtaining the required lead.

It is important to select the proper lead to monitor the ECG as the ECG signal displayed on-screen is used to obtain the heart rate, to synchronize energy shock delivery and to analyse heart rhythms in the Semi-Automatic Defibrillator mode. It is advisable to select a lead with the following characteristics:

- High and narrow QRS complex (>0.5mV recommended)
- The R wave must be above or below the baseline (but not biphasic)
- The height of the P wave must be inferior to 1/5 of the height of the R wave.
- The height of the T wave must be inferior to 1/3 of the height of the R wave.

The device also detects if any of the leads that form a part of the patient cable become detached or are improperly connected. When this occurs, the  icon will appear in the upper part of the device's screen. Depending upon which lead is off or improperly connected, the device may be able to allow the user to view a limited number of other leads. When it is not possible to view a lead and the user selects this lead, a broken line will be displayed on screen in the base line of the signal.

Changing the size (sensitivity) of the lead being viewed is performed by using the **SEN: 1** key located under the screen of the device. The sensitivity values available in the device are 0.5, 1, 2 and 4 cm/mV. To select the required sensitivity, press the key until obtaining the required size. The sensitivity selected appears both in the upper part of the screen beside the waveform, and in the key that allows the size to be selected.

The REANIBEX Serie 700 device allows the ECG signal to be viewed in cascade, that is, when this option is selected the lead will appear on-screen in 2 channels (9 seconds of the lead being viewed).

For those devices that offer the pulse oximeter option, in addition to the ECG signal in cascade, the pleth waveform (SpO2 curve) can be viewed in the second channel.



The selection of the information to be viewed in the second channel is made by using the

CH2: ECG key located under the screen. The options available for this key are:

- **CH2: - -** Only one ECG channel can be viewed on the device's screen
- **CH2: ECG** The ECG signal in cascade is viewed
- **CH2: SpO2** For devices that offer the pulse oximetry option, the pleth waveform can be viewed in the second channel.

4.5 Selecting the Filter

The selection of the filter for the ECG signal is made by using the fourth key located under the screen. The options available for this key are:

-  Muscle artifact filter: 0.67-40 Hz (only in recorder) When this filter is active, it eliminates potential disturbances in the ECG signal originating from muscle activity.
-  Diagnostic: 0.05-150 Hz (only in recorder) Whenever the muscle artifact filter is NOT selected, the device provides the full bandwidth.

The changes made by using this key when activated will apply to both the ECG signal on the screen and the printed signal from the recorder. However, screen limitations hinder the quality of the ECG that appears on-screen which is essential in making an accurate diagnosis.

In the Configuration of the device, the muscle artifact filter can be applied to the signal by default if this option is selected. See Section **11.5.1.1**.

4.6 Alarms

The REANIBEX Serie 700 allows alarm conditions to be detected in the different parameters monitored, according to a number of criteria set by the user. All the biological parameters alarms are high priority alarms.

Access to the screen that allows the alarm limits to be changed is obtained by first pressing the



menu key on the front panel, and then pressing the  key located below the device's screen. The screen that appears when this mode is accessed is as follows:

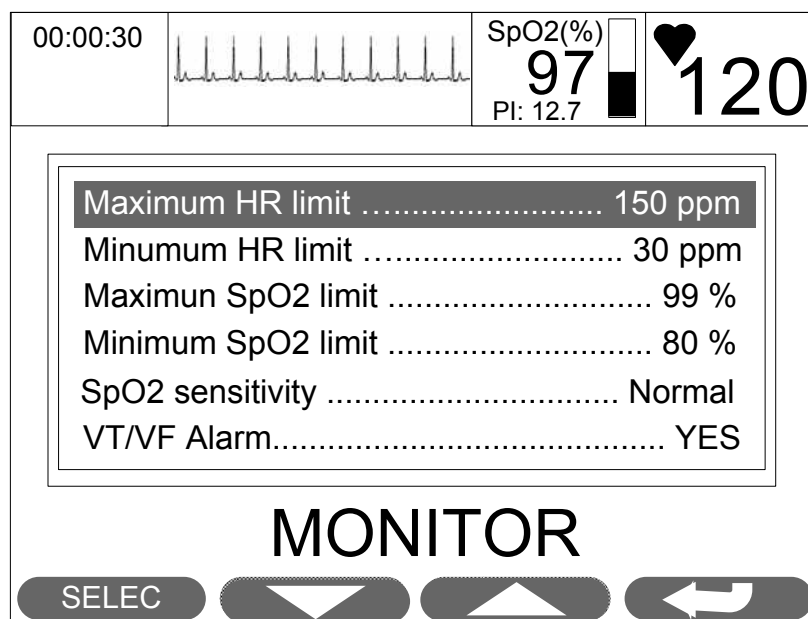



There are 5 alarm limits available that can be set by the user, as well as the sensitivity for the pulsioximeter:

- **Maximum HR Limit.** A higher Heart Rate limit can be set and when this limit is exceeded, the device will display a visual and acoustic indicator. This parameter can vary from 30 to 300 bpm and it changes in increments of 1 bpm.
- **Minimum HR Limit.** A lower Heart Rate limit can be set and when the patient's Heart Rate is under the set rate, the device will display a visual and acoustic indicator. This parameter can vary from 30 to 300 bpm and it changes in increments of 1 bpm. Its value can never be greater than the upper HR limit.
- **Maximum SpO2 Limit.** Only for devices that have pulse oximeter. It allows a saturation limit to be set and when this limit is exceeded, the device will display a visual and acoustic indicator. This parameter can vary from 85 to 100 % in increments of 1%.
- **Minimum SpO2 Limit.** Only for devices that have pulse oximeter. A saturation limit can be set and when the patient's SpO2 is under the set limit, the device will display a visual and acoustic indicator. This parameter can vary from 85 to 100 % in increments of 1%. Its value can never be greater than the upper SpO2 limit.

- **SpO2 Sensitivity.** Only for devices that have pulse oximeter. It allows a sensitivity mode to be set. This parameter can take three different values: Normal, Maximum, APOD (Adaptive Prove Off Detection).
- **VT/VF Alarm.** Only for devices that have the Semi-Automatic Defibrillator option. It allows the device to be configured so that it analyses the ECG signal and emits a warning if it detects potential Ventricular Fibrillation or rapid Ventricular Tachycardia.

Changes in the alarms are carried out by using the keys located below the screen. By using the

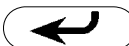
 key, the different alarms are selected (the selected alarm is shown in reverse video), meanwhile the  and  keys change the minimum values. The  key allows the user to return to the monitoring screen, performing procedures employed as well as the setting changes made to the alarms.

Changes in the alarms are only allowed in the MONITOR and MANUAL DEFIBRILLATOR modes, and in the latter, only when the device is not charging energy or in standby for delivering a shock.

When the device is switched on, the different alarms limits adopted depend upon the configuration of the device:

- If the configuration is set so that the alarm limits are FIXED, when the device is switched on, the values indicated in Configuration are always adopted by default.
- In all other cases, the device is configured for alarm limits that are PROGRAMABLE and it will record the limit values that were configured when the device was switched off and the next time it is switched on, it will adopt these values as start-up limits.

WARNING: There is a potential risk when using different alarm limits for the same or similar equipment in any area such as intensive care unit or operating room for heart surgery.

WARNING: Before each use, confirm that the alarm limits are appropriate for the patient being monitored. It must also be taken into account whether an operator will continually monitor the patient.

WARNING: Do not adjust the alarm limits to such extreme values that the alarm system is rendered useless.

4.6.1 HR and SpO2 Alarms

When an alarm condition occurs, either HR or SpO2 (only for devices that have the pulse oximeter option), the device will give both a visual (blinking of the indicator for the parameter that triggers the alarm) and acoustic indication.

The acoustic indication is automatically deactivated if the alarm condition disappears. During the alarm condition, the user can deactivate the acoustic indicator using the  key located on the front panel. This key will remain deactivated as long as no other alarm condition is present. When the acoustic indicator is suspended, the device's screen will show the same icon that appears on the front panel key which will automatically disappear when the alarm condition disappears.

Once the acoustic indicator has been deactivated, whether automatically or by an action on the part of the user, by pressing the key on the front panel, it will automatically reactivate after 2 minutes if the alarm condition is still present. If the indicator is suspended and an alarm occurs, it will visually and acoustically indicate the new alarm condition that developed.

The visual alarm indicator consists of the on-screen blinking of the parameter that triggered the alarm (HR and/or SpO2%). This on-screen indicator remains active for the duration of the alarm condition, meaning, until the parameter that triggered the alarm falls within the selected limits.

4.6.2 VT/VF Alarm

The VT/VF alarm is only available for those devices that have the Semi-Automatic Defibrillator option (ECG signal analysis capacity). This alarm is only active in the MONITOR and MANUAL DEFIBRILLATOR modes.

By activating this alarm, on-screen viewing and recorder will be limited to Lead II or the PADDLES. The VT/VF alarm will not be active, meaning the signal is not analyzed, if the

paddle lead, with reusable external or internal paddles has been selected and there is no patient cable. If the user has connected internal or external reusable paddles and the patient cable is connected, only Lead II can be analyzed.

If both the patient cable and the single-use multifunction electrodes are connected, and the user changes from the paddle lead to Lead II, or vice versa, signal analysis will begin once again.

The VT/VF alarm will be suspended in Manual Defibrillator mode if the device is charging, once it is charged, when reusable internal or external paddles are being connected and when it is changing over to Pacemaker mode (only for devices with this option).

By switching the device on, the alarm value will depend upon the configuration option which can be changed afterwards by the user.

When this alarm is active and is analysing the signal, the  icon appears in the upper part of the screen.

If the VT/VF alarm is triggered, meaning that potential Ventricular Fibrillation or rapid Ventricular Tachycardia is detected, the message “EXAMINE PATIENT” is periodically emitted both on-screen and audibly (optional configuration), and the screen icon related to this alarm starts to blink.

When there is an error in the Semi-Automatic Defibrillator operating mode, the VT/VF alarm will not be operative, and therefore it cannot be selected by using the screen that allows modification of the alarms.

5. Manual Defibrillation

5.1 Description

In this section, the basic functions of the REANIBEX Serie 700, operating in MANUAL DEFIBRILLATOR mode, are described.

In the MANUAL DEFIBRILLATOR mode, it is the user that must evaluate the ECG signal, decide if it is necessary to deliver a defibrillation shock, select the appropriate energy level, charge this energy and carry out the shock. In this operating mode, the device will not give any indication whatsoever of whether or not it is advisable to deliver a shock.

Devices that have the Semi-Automatic Defibrillator option allow the device to be configured so that in the Manual Defibrillator mode specific warning messages are audibly emitted.

In this operating mode, the alarms are available for modification at all times except when energy is being charged or it is in standby for delivering a shock.

In Manual Defibrillator Mode, ECG monitoring can also be carried out using the 4, 5 and 10 lead patient cable. The device detects the type of patient cable connected allowing all available leads to be monitored.

For those devices that have the pulse oximeter option, the % of SpO₂ can be monitored and the pleth waveform (optional), if required. This latter curve will always be displayed when selected and up to the time any key in the Defibrillator mode is activated, at which time, it disappears in order to display the standard messages of the mode that are already considered a priority.

Access to the Manual Defibrillator mode is carried out in 2 ways:

1. Once the device has been switched on, press the  key located on the front panel. Either the device was configured to switch on in Manual Defibrillator mode or if after operating in Manual Defibrillator mode, it switches to another operating mode and returns to Defibrillator mode (the device's memory recalls if it was in Manual or Semi-Automatic mode).

2. Press the **MANUAL** key located under the screen when the device is operating in Semi-Automatic mode (Only for devices with this option). Access to the Manual Defibrillator mode will depend upon the configuration of the device.
 - **Free access.** The Manual Defibrillator mode is directly accessed without any type of restriction.
 - **Access using a Passcode.** Access to the Manual Defibrillator mode requires an attributed passcode:

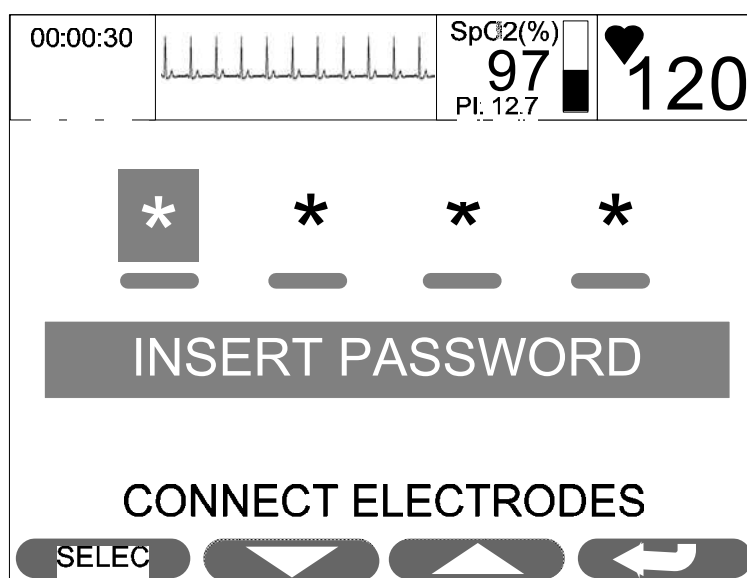

Using the keys located below the screen the access passcode to the Manual Defibrillator mode can be entered.

Once the passcode has been correctly entered, it is not necessary to enter it again whenever a change is made from Semi-Automatic Defibrillator mode to Manual Defibrillator mode.

- **Restricted Access.** Access to Manual Defibrillator mode is not permitted and therefore the aforementioned key does not appear in the lower part of the screen.

In any case the indicator located beside the **DEFIB 1** key must be illuminated, indicating that it is in Defibrillator mode.

In the lower part of the screen, which appears after accessing this mode, an energy indicator for the selected energy level is always displayed:

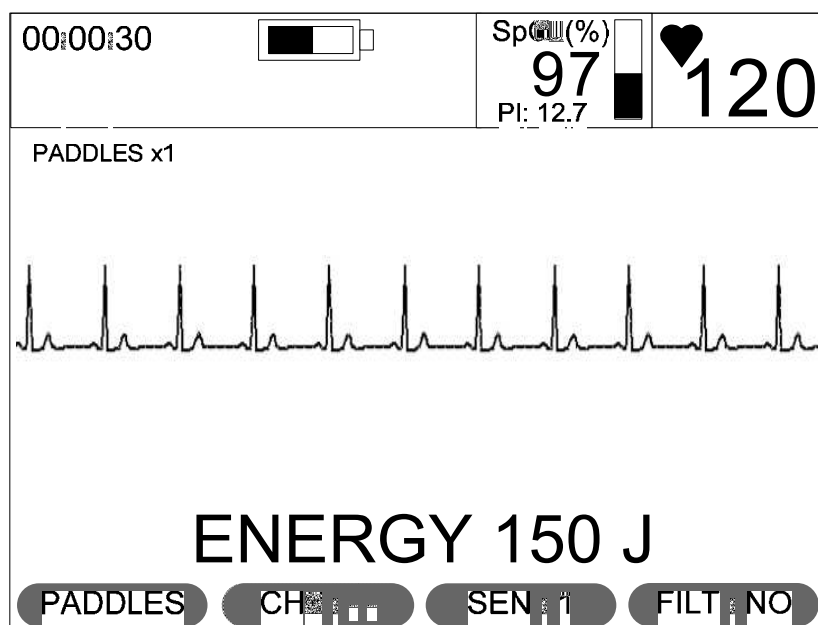

5.2 Warnings

WARNING: Electrical shock hazard. The defibrillator can deliver up to 200 Joules of electrical energy. When the shock is being carried out, make sure that no one touches the surface of the paddles or the single-use multifunction electrodes.

WARNING: Electrical shock hazard. Make sure that during defibrillation everyone stands clear and no one touches the patient, the bed or any conductive material that is in contact with the patient. The defibrillation current can partially shock through this person, causing injury to the user and to persons close to the device.

WARNING: Electrical shock hazard. If charged energy needs to be eliminated, do not discharge the defibrillator in the air. To dispose of the charged energy, change the energy level, change over to another operating mode or switch the defibrillator off.

WARNING: Burn and fire hazard and unsuccessful energy delivery. Do not discharge the reusable paddles on the single-use multifunction electrodes or on the monitoring electrodes. The reusable paddles or single-use multifunction electrodes must not touch each other or come into contact with the monitoring electrodes, leadwires, dressings, etc. These contacts

could result in electric arcs which cause skin burns to the patient and deviate a portion of the defibrillation energy.

WARNING: *Burn hazard to the skin of the patient. Air pockets formed between the defibrillation electrodes and the skin of the patient can cause burns during defibrillation. Ensure that the defibrillation electrodes are perfectly adhered to the skin of the patient. Once good skin contact is established, if the position of the electrodes must be changed, remove the electrodes and replace them with new ones.*

WARNING: *Burn hazard to the skin of the patient and unsuccessful energy delivery. Very dry or damaged electrodes can cause an electrical arc during shock resulting in burns to the skin of the patient.*

WARNING: *Burn hazard to the skin of the patient and unsuccessful energy delivery. Do not use the electrodes after their expiry date, not even if they have been opened. Replace the electrodes after every 50 shocks.*

WARNING: *Burn hazard to the skin of the patient and unsuccessful energy delivery. The conductive gel in the handles of the paddles can cause the energy shock to pass through the user during defibrillation. Clean the surface of the paddles and their handles thoroughly after performing defibrillation.*

WARNING: *Burn hazard to the skin of the patient and unsuccessful energy delivery. Do not allow the conductive gel to form a path on the patient's skin between the two defibrillation paddles, or between the single-use multifunction electrodes. This could cause an electrical arc between the paddles or the electrodes resulting in burns to the skin of the patient and a deviation of a portion of the defibrillation energy.*

WARNING: *Burn hazard to the skin of the patient and unsuccessful energy delivery. The leads of the patient cable could prevent the correct positioning of the electrodes of the defibrillation electrodes. Before performing any defibrillation, remove and disconnect all those elements that could interfere with it.*

WARNING: *Danger of potential interference with implanted electrical devices. Defibrillation can cause malfunction in the implanted devices. Whenever possible, position the paddles or the electrodes away from the implanted devices. As soon as defibrillation is concluded, check that the implanted device is functioning correctly.*

WARNING: Potential defibrillator shutdown. Defibrillator energy charging places a great demand for battery current. When the device is operating solely on batteries, and at the same time, the device is also charging the defibrillator, it can shutdown without any apparent indicator that the battery is low. If this occurs, replace the battery with a fully charged spare battery or connect the device to an external power supply.

WARNING: Potential equipment hazard. Before using the defibrillator, disconnect the patient from all equipment that is not defibrillator-protected.

5.3 Preparation for Defibrillation

The first step in Manual Defibrillation consists of connecting the proper defibrillation cable to the device, placing the paddles or electrodes as described in the following sections.

Take into account the following special considerations when placing both the electrodes and the reusable external paddles:

- **Obese patients or patients with large breasts.** Apply the electrodes or the paddles on a flat surface of the torso.
- **Thin patients.** Press the electrodes on the torso following the contour of the ribs to avoid air cavities.
- **Patients with implanted pacemakers.** Position the electrodes or the defibrillation paddles at least 10 cm from the generator and continue with the same procedure protocol as for any other patient with a cardiac arrest.
- **Patients with implanted defibrillators.** Position the electrodes or the defibrillation paddles at least 12-15 cm from the generator, and continue with the same procedure protocol as for any other patient with a cardiac arrest.

5.3.1 Utilization of Multifunction Single-Use Electrodes

For Manual Defibrillation with Single-Use Multifunction Electrodes, perform the following steps:

1. Check the expiry date of the electrodes and their packaging to make sure that are in perfect condition for use.
2. Prep the patient's skin for the application of the electrodes:
 - Remove chest hair from the patient if necessary. Avoid scraping or cutting the patient's skin. Avoid placing the electrodes or the paddles on broken or irritated skin.
 - Thoroughly clean and dry the patient's skin. Do not ever use either pure alcohol or ether to clean the patient's skin, since these products increase skin resistance.
3. Connect the single-use multifunction electrodes to the multifunction connector (MFC) of the REANIBEX Serie 700 as shown in the following figure.

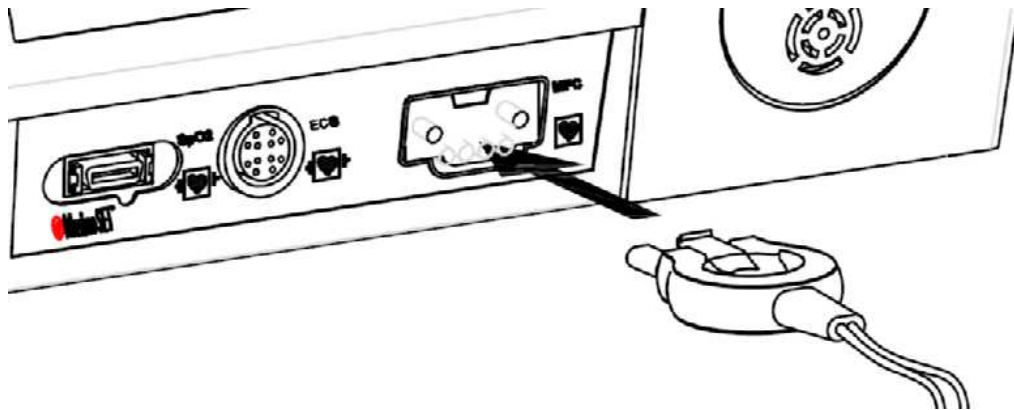

4. Position the electrodes on the patient's chest following the instructions on the electrodes packet or the guidelines that their procedure protocol sets out. For Manual Defibrillation using single-use multifunction electrodes, two positions are allowed.

- Anterior-lateral position

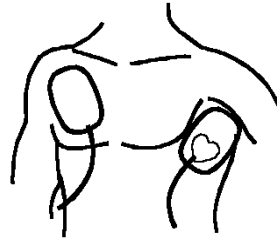

- Anterior-posterior position.

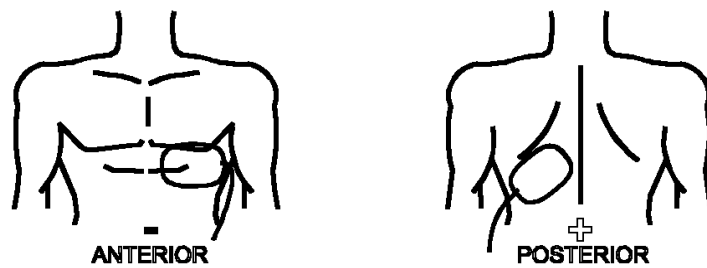

5.3.2 Utilization of Reusable External Paddles

For Manual Defibrillation with external reusable paddles perform the following steps:

1. Connect the reusable external paddles to the REANIBEX Serie 700 if they are not connected, just as is shown in the figure.

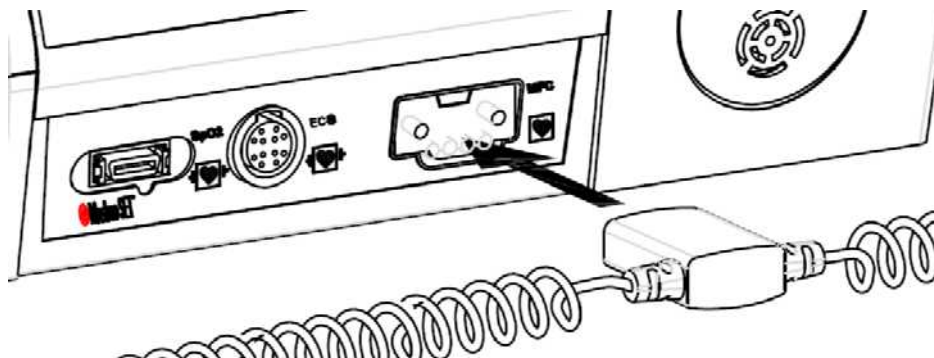

2. Prep the skin of the patient for the application of the paddles, as explained in the previous sections.
3. Apply conductive gel on the surface of the paddles.
4. Position the paddles on the patient's chest in the anterior-lateral position (or the position established in their protocol procedure), pressing to make sure that good skin contact is made.

5.3.3 Utilization of Paediatric Paddles

For Manual Defibrillation with paediatric paddles, perform the following steps:

1. Connect the reusable external paddles to the REANIBEX Serie 700 if they are not connected, just as is shown in the previous figure.
2. Keep the locking device, located in the front part of the paddle, pressed down.

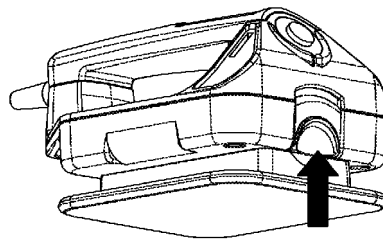

Slide the electrode of the adult paddle off, until the paediatric paddle appears.

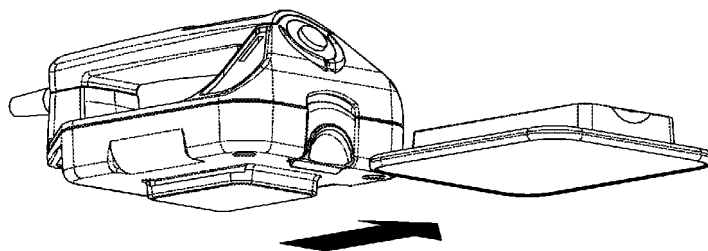

3. For defibrillation preparation, continue with the steps described in the previous section.

WARNING: *The physician will have to determine the appropriate energy level for defibrillation in paediatric patients.*

5.3.4 Utilization of Internal Paddles

Manual Defibrillation using internal paddles requires the following steps for connecting the paddles to the REANIBEX Serie 700:

1. Select the proper sized internal paddle electrode.
2. Connect the internal paddles to the multifunction connector (MFC) of the REANIBEX Serie 700 as shown in the figure:

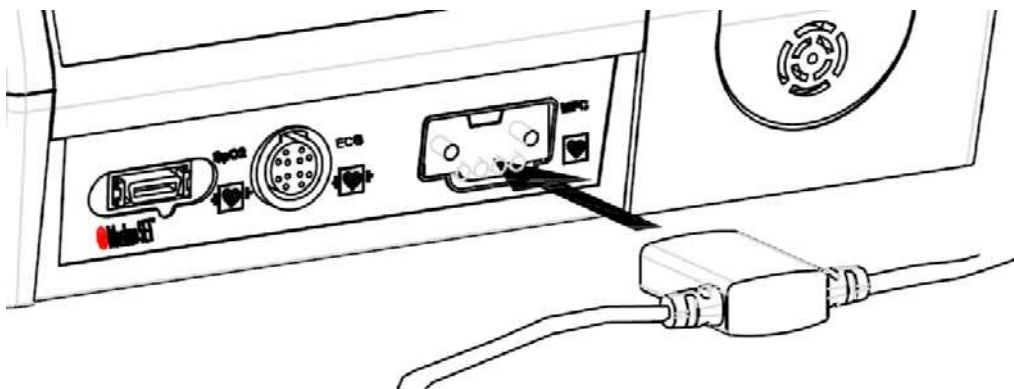

WARNING: *The REANIBEX Serie 700 has a maximum energy limitation of 50 J when the internal paddles are connected.*

5.4 Defibrillation Procedure

Once the type of paddles or electrodes to be used to carry out Manual Defibrillation have been selected, and the patient's skin has been prepped for the application of the paddles or electrodes, continue with the following steps for defibrillation:

- 1. Access the Manual Defibrillator mode and select the defibrillation energy level.**
Defibrillation energy selection can be carried out in two ways: by using the increase/decrease energy keys located on the front panel or if using reusable external paddles, by using the increase/decrease energy keys located in the Sternum paddle.

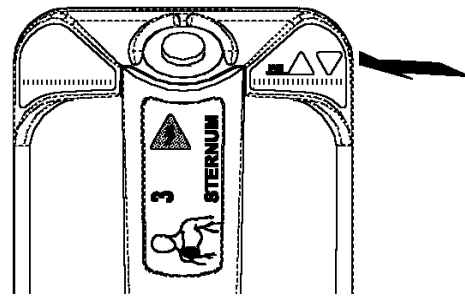
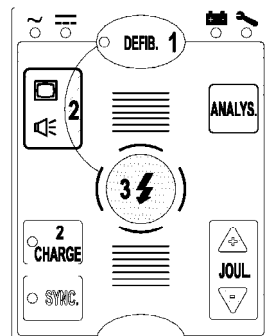

The energy levels available are 1 - 2 - 3 - 5 - 7 - 9 - 10 - 15 - 20 - 30 - 50 - 70 - 100 - 125 - 150 - 200 Joules.

If using internal paddles, the maximum energy that can be delivered is 50 J.

2. **Energy charging.** To charge the energy level, press the charge button located on the front panel. If reusable external paddles are being used, charging the energy level can also be carried out from the button located on the Apex paddle.

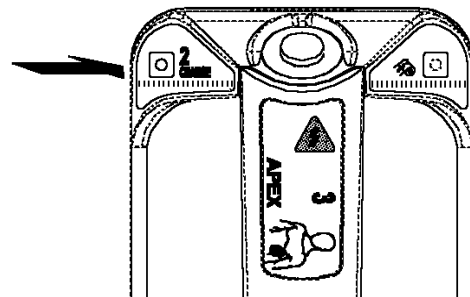
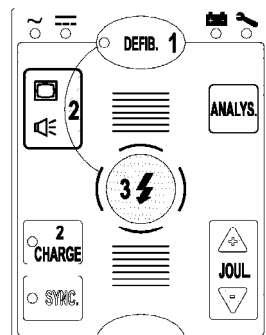

While the defibrillator is charging the selected energy, a progress bar is displayed on-screen and a high-pitched sound will be heard that increases in intensity indicating the energy status.

During charging, an internal discharge will take place if any of the following actions are performed:

- The increase/decrease energy keys on the front panel or on the paddles are pressed
- Any of the shock pushbuttons of the paddles which are being pressed down, are released

- The two shock pushbuttons of the paddles are simultaneously pressed, or the front panel shock key if single-use multifunction electrodes are being used.

If the energy is discharged internally, the device's screen will display the message "**NO SHOCK DELIVERED**" accompanied by a voice prompt (optional).

Once the energy is fully charged, the LED light on the Charge key, located on the front panel, will light up. The device will display the message "**PUSH TO SHOCK**" (this message will also be accompanied by a voice prompt in devices that have this option) and an intermittent sound will be heard.

If single-use multifunction electrodes or internal paddles are used, the shock pushbutton located on the front panel will also light up. In this case, the shock can only be performed from the front panel.

If reusable external paddles are used, the shock can only be performed from the paddles and therefore the front panel shock button will not light up.

When internal or external reusable paddles are used, once the energy has been charged, it will verify if the patient is connected. If the patient is not connected, the message "**PRESS PADDLES**" will be issued on-screen until the patient is properly connected. Once the paddles are connected, the message "**PUSH TO SHOCK**" will be given, and it will proceed in a similar manner to the previous case.

- 3. Delivering the energy to the patient.** Once the required energy has been charged, make sure that everyone stands clear and no one touches the patient, the bed or the device, and that there is nothing connected to the patient. To deliver the energy shock:
 - Press the shock button on the front panel, which will be blinking, if single-use multifunction electrodes or internal paddles are being used for defibrillation
 - Simultaneously press the shock pushbuttons on the reusable external paddles

If the energy is not delivered into the patient, the device's screen will display the message "NO SHOCK DELIVERED" accompanied by a voice prompt (optional). Otherwise, the selected energy will be displayed

If the energy is not delivered to the patient in less than 60 seconds from time the energy was fully charged, an internal discharge of the stored energy will take place.

NOTE: In the rest of the operating modes other than Manual Defibrillation, if any key in the Manual Defibrillation mode is pressed, the function will not take place and the message ***“SELECT DEFIBRILLATOR MODE”*** will be displayed on the screen, indicating the need to be in the Manual Defibrillator mode to execute the action associated with this key.

Blank sheet

6. Synchronized Cardioversion

6.1 Description

Synchronized cardioversion is a defibrillation procedure that allows the defibrillation energy shock to be synchronized with the R wave on the ECG signal from which the Heart Rate is obtained.

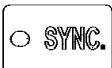
To activate the synchronization option, the  key located on the front panel must be pressed. When this option is active, the REANIBEX Serie 700 shows a marker over those points in which a R wave is detected (the marker position can vary slightly from one QRS complex to another). On printing the ECG signal, these markers will also be printed.

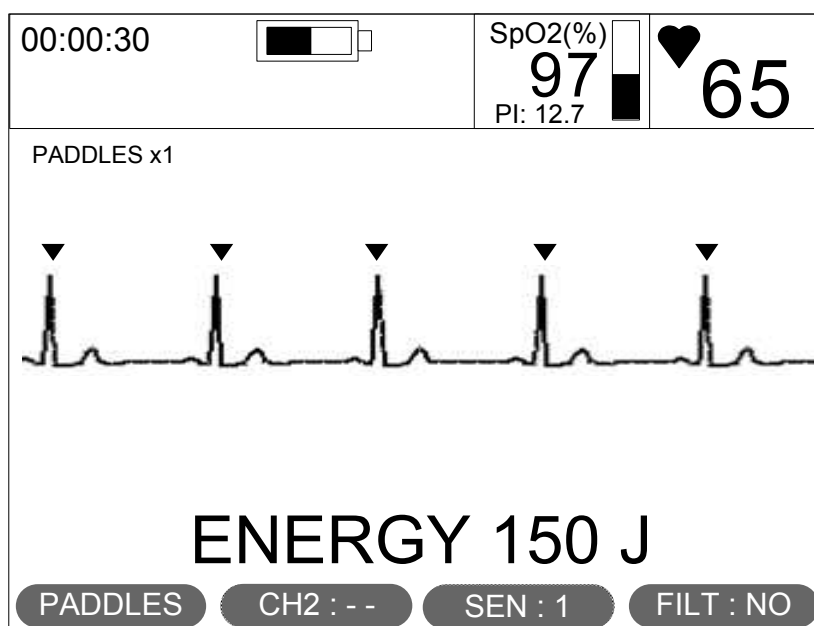

To perform synchronized cardioversion, both paddles and single-use multifunction electrodes can be used.

The REANIBEX Serie 700 allows configuration of the device so that synchronization can be maintained after delivering the shock in such a way that after each shock, it is not required to once again press the synchronization key. If a switch is made to another operating mode or the device turns off, the synchronism option will be deactivated. For more information consult the CONFIGURATION options.

6.2 Warnings

WARNING: *If monitoring the ECG signal is carried out only from reusable external paddles, artifact resulting from paddle movement can be interpreted as a R wave.*

WARNING: *Electrical shock hazard. Make sure that during defibrillation everyone stands clear and no one is touching the patient, the bed or any conductive material that is in contact with the patient. The defibrillation current can partially shock through this person, causing injury to the user and to persons close to the device.*

WARNING: *Burn and fire hazard and unsuccessful energy delivery. Do not discharge the reusable paddles on the single-use multifunction electrodes or on the monitoring electrodes. The reusable paddles or single-use multifunction electrodes must not touch each other or come into contact with the monitoring electrodes, leadwires, dressings, etc. These contacts could result in electric arcs which cause skin burns to the patient and deviate a portion of the defibrillation energy.*

6.3 Preparation for Synchronized Cardioversion

Before carrying out Synchronized Cardioversion, perform the following steps:

1. Prepare the procedure by carrying out the steps described in Section "**5.3 Preparation for defibrillation**".
2. If monitoring is going to be carried out using the 4, 5 or 10 lead patient cable, connect the cable to the REANIBEX Serie 700 and connect the monitoring electrodes according to the instructions described in section "**4.3.3 Positioning the monitoring electrodes**"
3. Select a lead that has optimum amplitude for the QRS complexes. To change the lead, use the **PADDLES** key located under the screen of the device.

6.4 Synchronized Cardioversion Procedure

Once the preparation described in the previous section has been carried out, continue with the following steps to perform Synchronized Cardioversion:

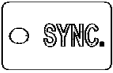
1. Switch the device on in Manual Defibrillator mode.
2. Press the  key on the front panel to activate synchronization. Make sure that the indicator light, located in the key, lights up and that the markers appear with each R wave detected. To deactivate synchronization, press the same key once again.
3. Select the required energy level and charge the energy following the instructions in Section "**5.4 Defibrillation Procedure**".
4. Once the required energy has been charged, make sure that everyone stands clear and no one touches the patient, the bed or the device, and that there is nothing connected to the patient.
5. Press and hold down the shock pushbutton on the front panel if using single-use multifunction electrodes or internal paddles or press and hold down the shock buttons on the external paddles, until the following R wave occurs, at which time the energy will be discharged.

From the time when the shock pushbutton on the front panel or the pushbuttons of the paddles are pressed until the R wave is detected on the device screen the message "**SEARCHING QRS**" will appear. If in 4 seconds no QRS is detected, the device will display the message "**NO QRS DETECTED**" and will initiate the search again. In this case, it is advisable to change the lead currently being used to detect the QRS to another (See previous section).

If external paddles are being used, when the shock buttons are no longer pressed, an internal energy discharge will occur and the message "**NO SHOCK DELIVERED**" will appear on-screen.

If multifunction single-use electrodes are being used, the shock pushbutton on the front panel can be released without causing the internal discharge to take place.

In any case, if the shock has not been delivered within 60 seconds after fully charging the energy, it will discharge internally and the message "**NO SHOCK DELIVERED**" will be displayed on-screen.

Once the energy has been charged and is on standby for carrying out the shock, if synchronization is deactivated, an internal discharge of the stored energy will take place.

6. After the defibrillation shock, observe both the patient and the ECG rhythm, and if more synchronized shocks are required, repeat the previous steps.



7. Semi-Automatic Defibrillation (AED) (Optional)

7.1 Description

In this section, the operation of the REANIBEX Serie 700 in Semi-Automatic Defibrillator (AED) mode is described, as well as the user guide messages that appear during the utilization of the device. In this operating mode, the device analyzes the patient's ECG signal and guides the user through the actions to perform according to the detected rhythm.

The configuration options allow the device to be configured so that it starts up in Semi-Automatic Defibrillator mode, and the operation of the device in this mode can be customized to better respond to the needs of the user (For more information on the configuration options, see Section "**11.5.1.3 Automatic Defibrillator**").

Access to the Semi-Automatic Defibrillator mode can be carried out in two ways:

- By pressing the  key on the front panel after switching the device on if the device has been configured to start-up in Semi-Automatic Defibrillator mode, or if after operating in Semi-Automatic Defibrillator mode, it changes over to another operating mode and then returns to Defibrillator mode (the device memory recalls if it was in Manual or Semi-Automatic mode).
- By pressing the  key located on the front panel when the device is operating in Manual Defibrillator mode.

In Semi-Automatic Defibrillator mode, only single-use multifunction electrodes can be used for defibrillation, and therefore if the device detects that the reusable internal or external paddles are connected, it will pass automatically to the Manual Defibrillator mode. This measure is adopted to prevent any potential risk to the patient.

The screen that appears when this operating mode is accessed is as follows:

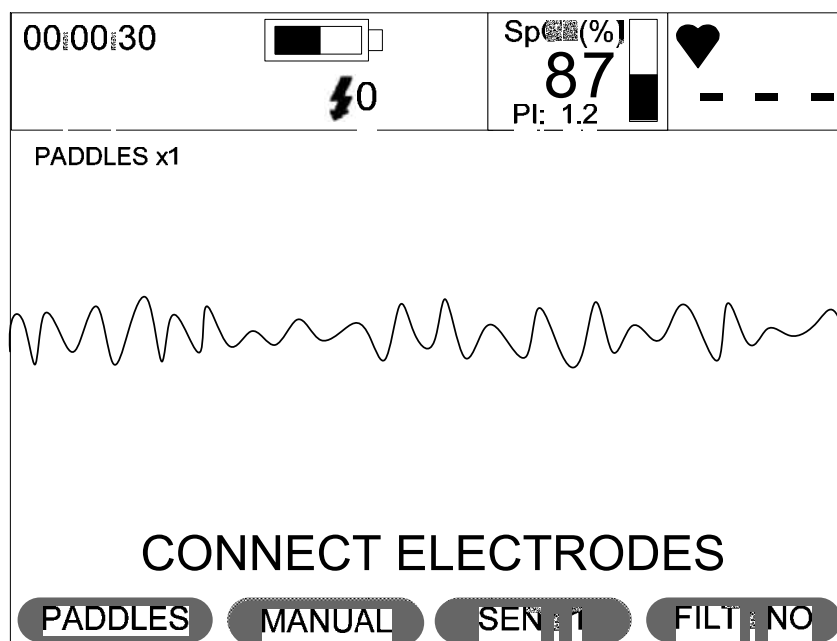

In the upper part of the screen, the number of defibrillation shocks that were delivered appears, while the lower part is reserved for user guide messages.

When the REANIBEX Serie 700 is operating in Semi-Automatic Defibrillator mode, on-screen viewing is limited to the single-use multifunction electrode lead (PADDLES) or to Lead II of the patient cable. Both Lead II and the PADDLES lead can be analysed, but only provided that the single-use multifunction electrodes are connected. If the lead viewed (PADDLES or Lead II) during the analysis of the ECG signal is changed, the device will once again begin the analysis cycle.

The pleth waveform cannot be viewed in Semi-Automatic Defibrillator mode as the lower part of the screen is reserved for issuing user guide messages, which are considered priority. The cascade signal cannot be viewed either.

During Semi-Automatic defibrillation, none of the keys in the Manual Defibrillator mode are active (SYNC, CHARGE, INCREASE/DECREASE ENERGY). Charging energy is carried out automatically when the device detects a shockable rhythm and if it detects Ventricular Tachycardia, the energy shock is automatically synchronized with the signal.

The alarms cannot be changed even though they are active. To modify the alarms, the device must be in Monitor or Manual Defibrillator mode.

The option of changing from Semi-Automatic Defibrillator mode to Manual Defibrillator depends upon whether or not this configuration is permitted. If this function is permitted through unrestricted access or by using a passcode, the **MANUAL** key will appear in the lower part of the screen.

If access to the Manual Defibrillator mode requires a passcode, when the **MANUAL** key is pressed, the passcode screen appears which allows this code to be entered. Once the correct code has been entered, access to the Manual Defibrillator mode is attained. If access is unrestricted, press the **MANUAL** key to gain direct access to the Manual Defibrillator mode.

7.2 Warnings

WARNING: *The REANIBEX Serie 700 when operating in Semi-Automatic Defibrillator mode (AED) was not designed to treat cardiac arrests in paediatric patients and therefore it must not be used in patients under eight years of age or weighing less than 25 kg.*

WARNING: *The device when operating in Semi-Automatic Defibrillator mode (AED), must never be used in patients who are conscious, who have a pulse or who breathe spontaneously.*

WARNING: *The device when operating in Semi-Automatic Defibrillator mode (AED), cannot be used with reusable internal or external paddles. When the connection of the external paddles is detected, the device will automatically changeover to Manual Defibrillator mode.*

WARNING: *Do not place the defibrillation electrodes in the anterior-lateral position when the device is operating in Semi-Automatic Defibrillator mode (AED) since an erroneous diagnosis can occur. The algorithm for the detection of shockable rhythms requires the electrodes to be placed in the anterior-lateral position (Lead II).*

WARNING: *Do not perform analyses in moving vehicles. Interference caused by motion artifact can affect the device and may result in erroneous diagnoses. Motion detection may also delay analysis.*

WARNING: *Do not move the device during the analysis. Moving the device can result in erroneous diagnoses. Do not touch the patient or the device during analysis.*

WARNING: *The detection sensitivity of shockable arrhythmias in patients with implantable cardiac pacemakers can decrease.*

WARNING: *The presence of radio frequency (RF) sources near the device can cause equipment malfunction.*

WARNING: *Burn hazard to the skin of the patient. Air pockets formed between the defibrillation electrodes and the patient's skin can cause burns during defibrillation. Ensure that the defibrillation electrodes are perfectly adhered to the skin of the patient. Once good skin contact is established, if the position of the electrodes must be changed, remove the electrodes and replace them with new ones.*

WARNING: *Burn hazard to the skin of the patient and unsuccessful energy delivery. Very dry or damaged electrodes can cause an electrical arc during shock resulting in burns to the patient's skin.*

7.3 Preparation for Semi-Automatic Defibrillation

Before beginning Semi-Automatic Defibrillation, perform the following steps:



1. Verify that the patient is in cardiac arrest. In other words, the patient presents the following symptoms:
 - Unresponsive (unconscious)
 - Is not breathing
 - Does not have a palpable pulse
2. Prep the patient's skin for the application of the electrodes:
 - Remove chest hair from the patient if necessary. Avoid scraping or cutting the patient's skin. Avoid placing the electrodes or the paddles on broken or irritated skin.

- Thoroughly clean and dry the patient's skin. Do not ever use either pure alcohol or ether to clean the patient's skin since these products increase skin resistance.
3. Make sure that the expiry date of the multifunction defibrillation electrodes has not expired and that their packaging is intact.
 4. Position the electrodes on the patient's chest in the anterior-lateral position following the instructions on the electrodes packet. Connect the cable of the electrodes to the REANIBEX Serie 700 if it has not been previously connected.

7.4 Semi-Automatic Defibrillation Procedure

Once the preparation for performing Semi-Automatic Defibrillation, indicated in the previous section, has been carried out, continue with the following steps:

1. **Access the Semi-Automatic Defibrillator mode.** Access to this operating mode can be

performed by pressing the  key or the  key depending upon the configuration and the previous operating mode (See Section "7. 1 Description")

Check that the patient cable is properly connected. If the cable or the electrodes are not properly connected, the device will emit "*CONNECT ELECTRODES*" both on-screen and by voice prompt, whereas if the electrodes are not properly connected, the message "*PRESS ELECTRODES ON THE PATIENT*" will be emitted.

2. **Follow the visual on-screen and voice prompt instructions.** Once both the cable and the electrodes are properly connected, the REANIBEX Serie 700 begins analysis of the ECG signal, emitting the message "*STAND CLEAR*" both on-screen and by voice prompt.

During analysis of the signal, which takes approximately 10 seconds, the device displays and emits the message "*ANALIZING NOW. STAND CLEAR*" on-screen.

If during analysis of the signal the viewed lead is changed, a new analysis cycle will begin once again.

Once the analysis has been performed, two possible cases can arise:

A) NO SHOCK ADVISED

The device detects that the patient has a rhythm that does not require defibrillation, and emits the message *"NO SHOCK ADVISED"*. The shock pushbutton will remain disabled since it is not necessary to deliver the shock. Afterwards, the device initiates the Cardiopulmonary Resuscitation time period, emitting the message **"IF NO SIGNS OF ACTIVITY, INICIATE CPR"**. During this time period, which can be configured, the screen displays a progress bar and a counter that indicates the remaining time to perform CPR. As soon as the CPR time period is finished, the device automatically begins a new analysis.

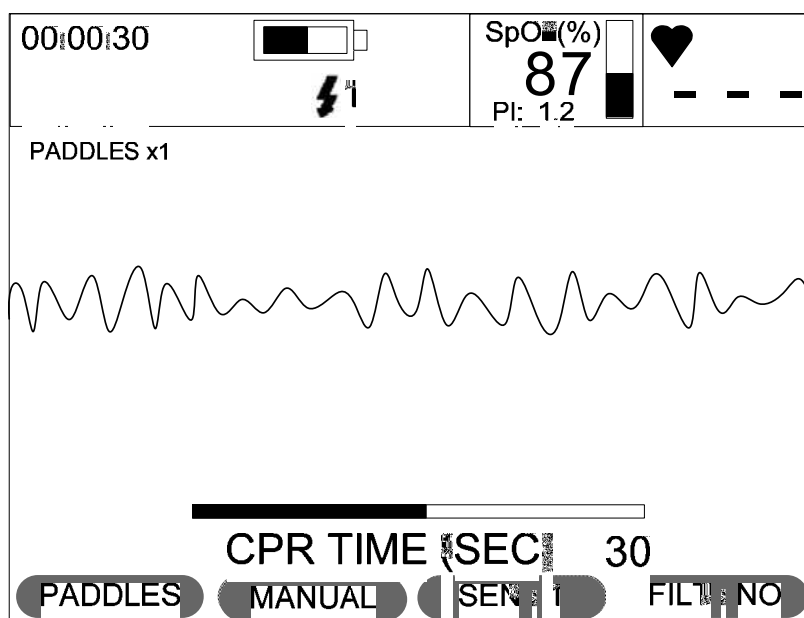

This CPR time period can be suspended at any time and an analysis initiated by pressing

the  key on the front panel.

If the CPR time period was set on OFF in the configuration options, this time period is suspended, meaning that neither the progress bar or the counter appear on-screen, and

the message *"PRESS ANALYSIS TO START"* is emitted. In this case, the  key must be pressed to start a new analysis.

B) SHOCK ADVISED

The device detects that the patient has a rhythm that requires defibrillation and emits the message "**SHOCK ADVISED**". The REANIBEX Serie 700 will automatically charge to the first of the three energy levels set in configuration. During the charging process, an on-screen progress bar appears and a high-pitched sound will be heard that increases its intensity, indicating the charge status.

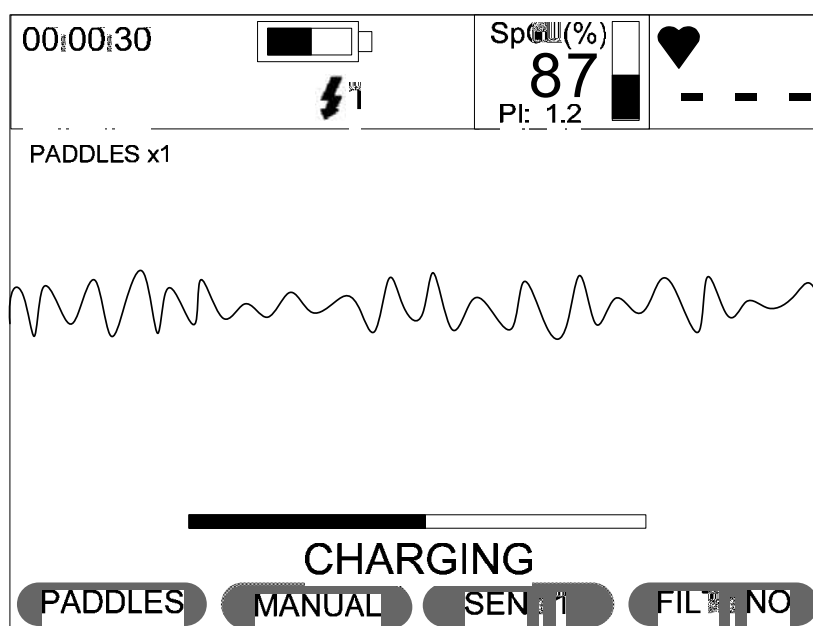

When energy charging is concluded, the message "**STAND CLEAR**" is emitted.

3. **Press the shock button if the REANIBEX Serie 700 indicates this action.** Once the device has detected that the patient presents a shockable rhythm and has charged the energy, it is ready to shock. At this time, the shock button is illuminated, emitting an alternating sound and the device emits the message "**PUSH TO SHOCK**". Before discharging the energy make sure that no one is touching the patient, the bed or the device, and that there is nothing connected to the patient.

To deliver the shock, press the shock button on the front panel. Once the shock has been delivered the shock indicator on the upper part of screen will increase its value.

If the energy is not discharged in less than 15 seconds, an internal energy discharge will take place, and the device will emit the message "**NO SHOCK DELIVERED**".

Depending upon the configuration of the device (number of consecutive shocks), after delivering the shock, the REANIBEX Serie 700 will initiate a new analysis cycle until

consecutively delivering a number of shocks equal to the number set in the "Consecutive Shocks" parameter, or it will enter into the CPR time period (if the number of consecutive shocks is set at 1).

8. Transcutaneous Pacemaker (Optional)

8.1 Description

In this section, the operation of the REANIBEX Serie 700 in Pacemaker mode is described as well as the considerations to be taken into account when pacing is performed.

Cardiac stimulation by transcutaneous Pacemaker is a technique which is rapidly and easily applied in emergency situations, to those patients who present episodes of asystole or symptomatic bradycardia. The pacemaker pulses are delivered by means of single-use multifunction electrodes.

Access to this mode is carried out by using the  key located on the front panel. Make sure that the LED indicator located on the key turns on. The configuration options allow the initial status to be determined for this operating mode.

In Pacemaker mode, only single-use multifunction electrodes can be used to deliver therapeutic pulses, therefore if the device detects that the reusable internal or external paddles are connected, it will emit the message “**CONNECT ELECTRODES**”. In this operating mode, the single-use multifunction electrodes cannot be used for monitoring the ECG signal, so the patient cable must always be used to perform this function.

The screen that appears when this operating mode is accessed is:

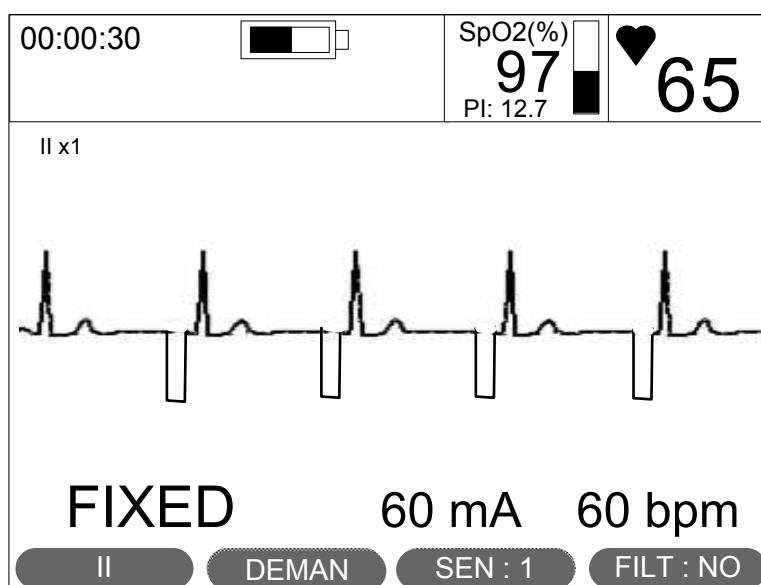

In the lower part of the screen, the pacing parameters for the Pacemaker mode appear: Rate, amplitude and pacing mode.

Whenever a pacemaker pulse is provided, a spike is displayed, superimposed over the ECG signal at the same time this pulse is emitted.

When the REANIBEX Serie 700 is operating in Pacemaker mode, the pleth waveform cannot be viewed as the lower part of the screen is reserved for displaying the pacing parameters. The alarms cannot be changed even though they are active. To modify the alarms, the device must be in Monitor or Manual Defibrillator mode.

During pacing with the pacemaker, none of the Defibrillator mode keys are active, so that if any of these keys are pressed, the designated function will not take effect and the message "**SELECT DEFIBRILLATOR MODE**" will appear indicating that this key is active only in Defibrillator mode.

8.2 Warnings

WARNING: *Continuously observe the patient during pacing by the Pacemaker. Do not rely neither on the Heart Rate alarms nor on the Heart Rate shown by the device as an indicator of the patient's perfusion status. In the course of time, the patient's response to therapy can change.*

WARNING: *Use the Pacemaker in On-Demand mode whenever possible. Use the pacemaker in Fixed mode when artifact or noise from the ECG signal does not allow accurate and reliable detection of the R wave or when the patient cable is not available.*

WARNING: *If the Pacemaker is used in On-Demand mode, the patient cable must be connected to the device.*

WARNING: *Pacing with the Pacemaker could result in burns to the patients skin especially with high-voltage currents.*

WARNING: *If pacing with the Pacemaker is carried out for prolonged periods of time, it may be necessary to periodically change both the defibrillation electrodes and the monitoring*

electrodes. Consult the related manufacturer's documentation to determine how often they should be changed.

WARNING: *Exercise caution when handling the single-use multifunction electrodes during cardiac stimulation with the pacemaker in order to prevent accidental shocks.*

WARNING: *If the Pacemaker mode is used with the device operating only on battery power and a low battery indicator appears, immediately connect the device to an external power supply source.*

8.3 Preparation for pacing with the Pacemaker

Before initiating cardiac stimulation with the Pacemaker, perform the following steps:

1. Check the expiry date, and the packaging of the single-use multifunction electrodes, and make sure that they are in perfect condition.
2. Connect the single-use multifunction electrodes to the REANIBEX Serie 700.

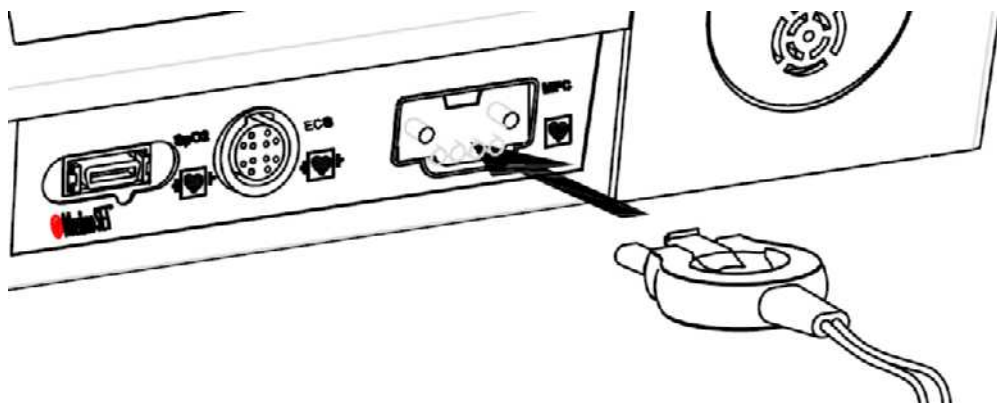

3. Prep the patient's skin as has been explained in previous sections and position the single-use multifunction electrodes following the manufacturer's instructions or your organization's protocol procedure.
4. If pacing with the Pacemaker in On-Demand mode is going to be performed, connect the patient cable to the REANIBEX Serie 700, and connect the defibrillation electrodes according to that described in Section "**4.3.3 Positioning of the monitoring electrodes**".

NOTE: During operation with the Pacemaker, signal capture using the single-use multifunction electrodes is not performed. If this lead (PADDLES) is selected, a solid line will appear on top of which the Pacemaker spikes are superimposed.

8.4 Fixed Mode and On-Demand Mode

The REANIBEX Serie 700 allows cardiac stimulation with the Pacemaker to be performed in two different ways:

- **On-Demand Mode.** In this pacing mode, pacing pulses are only delivered when the patient's heart rate is less than the selected rate in the pacemaker. This is the recommended pacing mode since the patient's intrinsic beats are taken into account.

If this pacing mode has been selected, it requires a patient cable connected to the device in order to monitor the ECG signal. The single-use multifunction electrodes are only used for delivering the therapy.

- **Fixed Mode.** In this pacing mode, the pacing pulses are emitted at a fixed rate, which is selected in the Pacemaker, regardless of the patient's intrinsic beats. This pacing mode does not require a patient cable connection since the patient's ECG signal is not taken into account.

Access to either one of the pacing modes is performed by means of a key located below the device screen. When the device is operating in FIXED mode, this key will allow the changeover to the **DEMAND** mode, whereas if it is in the ON-DEMAND mode, it will allow the changeover to the **FIXED** mode.

8.5 Pacemaker Pacing Procedure

Once the preparation indicated in the previous section to perform pacing in the Pacemaker mode has been carried out, perform the following steps:

1. Access the Pacemaker Mode by pressing the corresponding key on the front panel.

When the Pacemaker mode is accessed for the first time after the device has been switched on, the pacing parameters set in the configuration options (See Section "11.5.1.4 Pacemaker") are adopted as the pacing parameters.

In the lower part of the screen, the pacing mode is displayed as well as the pulse rate and amplitude.

If the pacing mode at start-up is On-Demand and Fixed mode is required, press the

FIXED

key located under the screen. If the pacing mode is Fixed and On-Demand is

required, press the **DEMAND** key located under the screen.

2. If pacing is performed in the ON-DEMAND mode, select the most appropriate lead, so that the R wave can be easily detectable. If necessary, change the viewed lead.
3. If necessary, adjust both the rate and the amplitude of pacing using the keys on the front panel.

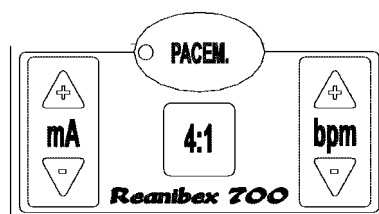

Variations in both the rate and amplitude of pacing can be observed in the lower part of the device's screen, where the values of the selected amplitude and rate appear at all times.

The amplitude can vary from 0 to 150 mA in increments of 5 mA, whereas the rate can vary from 30 to 180 bpm in increments of 5 bpm.

4. Check that the Pacemaker spikes appear on the ECG signal and that cardiac capture has occurred. Cardiac capture is observed when immediately after a Pacemaker spike, a QRS complex appears.

If operating in On-demand mode, beats can appear that are not associated with any Pacemaker spike. Furthermore, if the patient's intrinsic rate is greater than that of the Pacemaker stimulation, no pacing pulse will be delivered.

To interrupt pacing and view the intrinsic rhythm of the patient, keep the  key pressed down. While this key is kept pressed down, the Pacemaker pacing rate is reduced by 4, allowing the patient's rhythm to be observed.

5. If capture does not take place, increase the pacing amplitude until it occurs. If capture does occur, try to reduce the pacing amplitude to the level that allows capture to be maintained.

Evaluate the option of administering sedation or analgesics to the patient in cases where he/she experiences discomfort.

6. Check that mechanical capture is present by taking the pulse of the patient or checking his/her blood pressure.
7. If pacing needs to be stopped, reduce the pacing amplitude to 0 mA or change the operating mode.

If during pacing in On-Demand mode any of the patient cable leads are off and the selected lead cannot be obtained, the REANIBEX Serie 700 will continue pacing at a fixed rate that will be set by the user, until the lead is once again connected. During this time a solid line will be displayed on-screen, and the pacemaker spikes will be superimposed on top of it at the established rate.

If an amplitude of 0 mA has been selected, no pacemaker pacing pulse will be emitted, and the device will display the message "**SELECT AMPLITUDE**".

If during pacing the single-use multifunction electrodes become disconnected in any mode, the message "**CONNECT ELECTRODES**" will appear and no pacing pulses will be delivered until the electrodes are once again connected.

9. Pulse Oximetry (optional)

9.1 Description

The REANIBEX Serie 700 offers the option of a pulse oximetry module that allows non-invasive monitoring functional oxygen saturation of arterial haemoglobin (SpO₂) and pulse rate. In this section, the purpose of pulse oximetry is explained as well as how to use this available function in the REANIBEX Serie 700.

Pulse Oximetry is a non-invasive method to measure the oxygen saturation in arterial blood. The reading of the SpO₂% value indicates the percentage of hemoglobin molecules in the arterial blood that are saturated by oxygen.

When the device has this option, in the upper part of the screen together with the Heart Rate indicator, the numerical value of the saturation is shown as "SpO₂ (%)", along with the signal intensity indicator that appears to the right of this value, and the Perfusion Index, indicated as PI, which is shown under the saturation indication. Perfusion Index is a value that indicates arterial pulse signal strength as the percentage of pulsatile signal to non-pulsatile signal. The perfusion index allows clinicians to place sensors on optimal sites. This parameter is also useful as a troubleshooting tool by helping a clinician rule out whether a questionable value is due to low perfusion or ambient noise.

For devices that do not have the SpO₂ option, the indicator of the remaining battery percentage appears in this place.

The pleth waveform can only be viewed in Monitor or Manual Defibrillator mode, and in the latter mode the curve is no longer displayed on-screen whenever any of the keys in the Defibrillator mode is pressed. To view this curve press the key designated C2 located, below the device's display, screen until the curve appears.

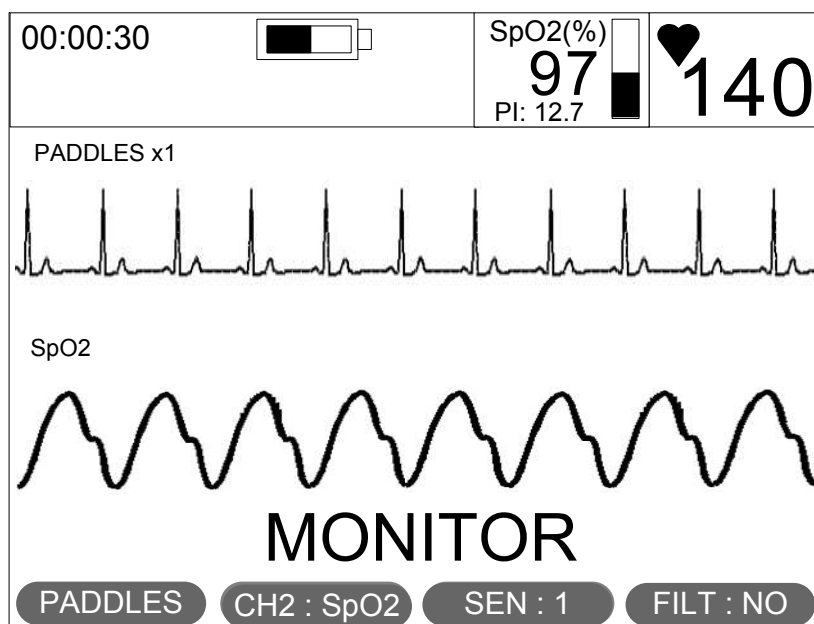

When only the SpO2 sensor is connected to the patient and there are no available leads, the pulse rate obtained by the pulse oximetry module appears as the Heart Rate.

9.2 Warnings

WARNING. SHOCK OR BURN HAZARDS: Before use, carefully read these operating instructions, the sensor and cable directions for use, and precautionary information.

WARNING: Using other manufacturers' sensors or cables may cause improper oximeter performance and invalidate safety agency certifications. Use only sensors and cables that are specified in these operating instructions.

WARNING. INACCURATE READINGS HAZARDS: Do not use a damaged sensor or cable. Do not alter the sensor or cable in any way. Alterations or modification may affect performance and/or accuracy. Never use more than one cable between the pulse oximeter and the sensor to extend the length.

WARNING: Do not rely only on the pulse oximeter readings. Continuously examine the patient. Inaccurate readings of the SpO2 value can occur due to different factors:

- Application or incorrect use of the sensor

- *High levels of Carboxyhemoglobin (COHb) or Methemoglobin (MetHb) in the blood*
- *Exposure to excessive lighting, such as surgical lamps (especially those that have xenon sources), bilirubin lamps, fluorescent lights, infrared heat lamps and the direct sunlight*
- *Injected dyes such as methyl blue*
- *Certain nail deformations, nail polish and fungi*
- *The positioning of the sensor in an extremity that has a blood pressure cuff, an intravenous line or that has restricted blood circulation.*
- *Severe anemia*
- *Excessive patient movement*
- *Electrosurgica interference*

WARNING: *The pulsations from intra-aortic balloon support can be additive to the pulse rate on the oximeter pulse rate display. Verify patient's pulse rate against the ECG heart rate.*

WARNING: *The incorrect application of the sensor can produce injury to the patient's skin and inaccurate readings. Make sure that the sensor is not too tight.*

WARNING: *Do not leave the sensor in the same position for prolonged periods of time. Periodically check the position of the sensor, at least every eight (8) hours, to evaluate the condition of the patient's skin. If any alterations are observed in the patient's skin, change the location of the sensor.*

ADVERTENCIA: *The site must be checked at least every eight (8) hours to ensure adequate adhesion, circulation, skin integrity and correct optical alignment. Do not use tape to hold the sensor in place as this may cause inaccurate readings or damage to the sensor or skin.*

WARNING. POSSIBLE STRANGULATION: *Carefully route patient cabling to reduce the possibility of patient entanglement or strangulation.*

WARNING: *Do not use the pulse oximeter or the sensor in the presence of strong electromagnetic fields such as electrosurgical units. Do not use the pulse oximeter or the sensor during Computerized Axial Tomography (CAT). Do not use the pulse oximeter or the sensor during Magnetic Resonance Imaging. The indirect current can cause burns and the pulse oximeter could affect the image obtained by magnetic resonance.*

WARNING. POSSIBLE EQUIPMENT DAMAGE: *To avoid damage to the cable, always hold by the connector rather than the cable, when connecting or disconnecting either end.*

WARNING: *Do not soak or immerse the sensors or cables in any liquid solution. Do not attempt to sterilize.*

NO IMPLIED LICENSE. *Possession or purchase of the pulse oximeter does not convey any expressed or implied license to use the pulse oximeter with unauthorized sensors or cables which would, alone or in combination with this device, fall within the scope of one or more of the patents relating to this device.*

Product covered by one or more of the following U.S. Patents: 5.758.644, 5.823.950, 6.011.986, 6.157.850, 6.263.222, 6.501.975, 7.469.157 and other applicable patents listed at: www.masimo.com/patents.htm.

Masimo, SET, Signal Extraction Software, LNCS, and LNOP are registered trademarks of Masimo Corporation.

9.3 Operation of the pulse oximetry

Pulse oximetry is a continuous and non-invasive method of measuring the level of arterial oxygen saturation in blood. The measurement is taken by placing a sensor on a patient, usually on the fingertip for adults, and the hand or foot for neonates. The sensor connects to the equipment with a patient cable. The sensor collects signal data from the patient and sends it to the equipment.

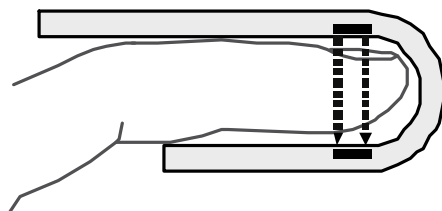

Pulse oximetry is governed by the following principles:

1. Oxyhemoglobin (oxygenated blood), deoxyhemoglobin (non-oxygenated blood), carboxyhemoglobin (blood with carbon monoxide content) and methemoglobin (blood

with oxidized hemoglobin content) species differ in their absorption of visible and infrared light.

2. The amount of arterial blood in tissue changes with your pulse (photoplethysography). Therefore, the amount of light absorbed by the varying quantities of arterial blood changes as well.

The equipment uses a multi-wavelength sensor to distinguish between oxygenated blood and deoxygenated blood. Signal data is obtained by passing various visible and infrared lights (LED's, 400 to 1000 nm) through a capillary bed (for example, a fingertip, a hand, a foot) and measuring changes in light absorption during the blood pulsatile cycle.

The photodetector receives the light, converts it into an electronic signal and sends it to the equipment for calculation. Once the equipment receives the signal from the sensor, it utilizes Masimo SET signal extraction technology to calculate the patient's functional oxygen saturation and pulse rate.

9.4 Pulse Oximetry Sensors

An important aspect is choosing the proper sensor. Use the following criteria to select a suitable sensor:

- Patient's weight
- The patient's perfusion status in the extremities. Perfusion of the areas can be improved by rubbing them or warming them.
- Activity level of the patient
- Available application areas on the patient's body
- Sterility requirements
- Expected duration of the monitoring

The sensors are designed to be applied in a specific area of the patient's body according to his/her weight. This is based on an important aspect to guarantee the reliability of the data obtained, meaning that in order to apply the sensor properly, the emitter and the photodetector must be directly opposite each other.

To ensure optimal performance:

- Use a dry sensor, that is appropriate for the patient
- Maintain the place where the sensor is positioned at the same level as the patient’s heart
- Make sure that the sensor is not too tight
- Avoid positioning the sensor in an extremity that has a blood pressure cuff, an intravenous line or that has restricted blood circulation.
- Avoid taking measurements in places with very bright lighting
- Apply the sensor according to the instructions for use provided by the manufacturer and take into account all the warnings and precautions that are indicated therein.

There are two types of pulse oximetry sensors available:

- **Reusable sensors.** They can be used on different patients once cleaned and disinfected.
- **Single-Use sensors.** They must be used only once and never on different patients, and must be disposed of after use.

The sensors provided by the manufacturer for each patient type are:

M-LNCS™ REUSABLE SENSORS			
Sensor	Description	Preferred Application Site	Weight Range
M-LNCS™ DCI®	Adult Reusable Finger Sensor	Finger	> 30 Kg
M-LNCS™ DCIP	Pediatric Reusable Finger Sensor	Finger	10 – 50 Kg
M-LNCS™ TC-I	Reusable Ear Sensor	Ear Lobe	> 30 Kg
M-LNCD™ YI	Reusable Multi-site Sensor	Foot	1 – 3 Kg
		Finger	> 3 Kg
M-LNCS™ TF-I	Reusable Forehead Sensor	Forehead	> 30 Kg

M-LNCS™ ADHESIVE SENSORS			
Sensor	Description	Preferred Application Site	Weight Range
M-LNCS™ Aadx	Adult Adhesive Sensor, 18 in.	Finger / Toe	> 30 Kg
M-LNCS™ Aadx-3	Adult Adhesive Sensor, 3 ft.	Finger / Toe	> 30 Kg
M-LNCS™ Padx	Pediatric Adhesive Sensor, 18 in.	Finger / Toe	10 – 50 Kg
M-LNCS™ Padx-3	Pediatric Adhesive Sensor, 3 ft.	Finger / Toe	10 – 50 Kg
M-LNCS™ Inf	Infant Adhesive Sensor, 18 in.	Thumb / Great Toe	3 – 20 Kg
M-LNCS™ Inf-3	Infant Adhesive Sensor, 3 ft.	Thumb / Great Toe	3 – 20 Kg
M-LNCS™ Neo	Neonate Adhesive Sensor, 18 in.	Hand / Foot	< 3 Kg
		Finger / Toe	> 40 Kg
M-LNCS™ Neo -3	Neonate Adhesive Sensor, 3 ft.	Hand / Foot	< 3 Kg

		Finger / Toe	> 40 Kg
M-LNCS™ NeoPt	Sensitive Skin Neonate Adhesive Sensor, 18 in.	Hand / Foot	< 1 Kg
M-LNCS™ NeoPt -3	Sensitive Skin Neonate Adhesive Sensor, 3 ft.	Hand / Foot	< 1 Kg
M-LNCS™ NeoPt-500	Neonate Non-adhesive Sensor, 3 ft.	Hand / Foot	< 1 Kg
M-LNCS™ Blue	Neonate, infant and pediatric adhesive	Hand / Foot	2.5 – 30 Kg

9.5 Monitoring pulse oximetry

To monitor the SpO₂, perform the following steps:

1. Connect the extension cable of the SpO₂ sensor to the REANIBEX Serie 700 as shown in the figure, and then connect the appropriate sensor to the abovementioned extension cable.

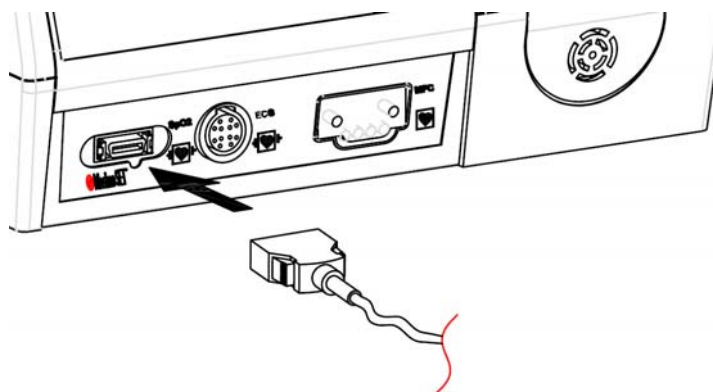

2. Apply the sensor to the patient
3. Switch on the REANIBEX Serie 700. In the upper part of the device's screen, " - - " will appear until the first valid measurement of saturation is obtained. Once the SpO₂% has been obtained, it will be constantly updated, and the signal intensity indicator as well.

4. Adjust the alarm limits for the SpO₂% value according to that described in Section "4.6 Alarms".
5. If viewing of the pleth waveform is required, press the key designated "C2" located below the device screen, until the waveform appears.
The pleth waveform can only be viewed in Monitor and Manual Defibrillator modes. In the Manual Defibrillator mode, this curve will be displayed until any of the defibrillator keys are activated.

If the SpO₂ sensor is connected to the device but is not connected to the patient, instead of the SpO₂% indicator, the  icon appears, indicating that the sensor must be connected to the patient.

If any error is detected in the pulse oximetry module during the self-tests that the device performs, instead of the SpO₂% indicator, the  icon appears indicating that this module is not operative.

10. Recorder (Optional)

10.1 Description

In order to document cardiac activity, the REANIBEX Serie 700 has a small, lightweight and versatile high-resolution recorder that can print up to two channels, as well as the corresponding entries. The size of the paper that the recorder accepts is 50 mm.

The recording consists of the following components:

- Heading
- Initial data relating to the signal that is going to be printed.
- Biological signals, ECG and/or pleth waveform (only for the devices with this option)
- Entries relating to the signal

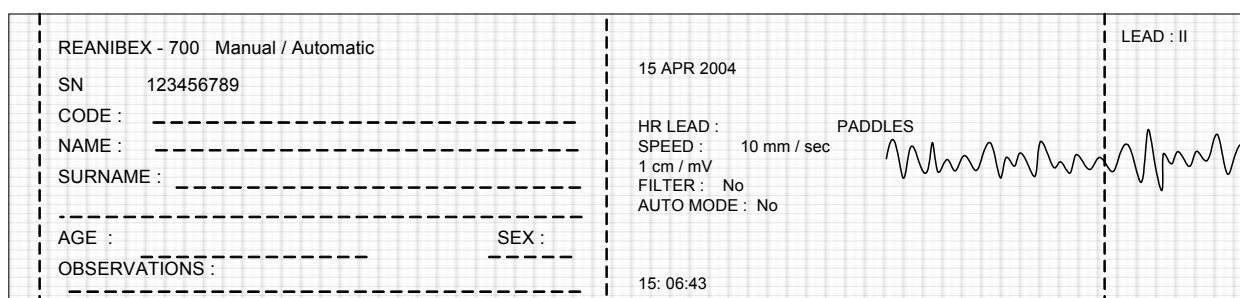



10.2 Configuration of the recorder

The REANIBEX Serie 700 can configure a series of parameters that affect the operation of the recorder.

1. **HEADING** – It can determine whether or not a heading is printed to enter data related to the patient for each recording.
2. **PAPER** – It can configure leaving a blank margin on the paper to prevent cutting the recording when you cut the paper.
3. **SPEED** - Determines the printing speed of the recorder. 10, 25 or 50 mm/sec.
4. **DELAY** - It allows the signal to be printed with an 8 second delay with respect to the signal that is viewed on-screen.

5. AUTOMATIC MODE - When this option is activated, the REANIBEX Serie 700 will print a strip of paper with the 8 seconds prior to and after an alarm signal or a defibrillation shock.

For more information about these parameters consult Section "11.5.1.5 Recorder".

When the device is operating in any mode, by pressing the Menu  key on the front panel and then pressing the  key, the automatic mode, delay and speed parameters can be changed.

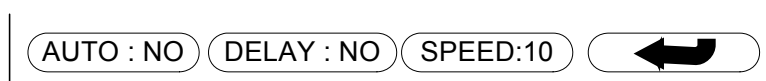



To change the parameter, press the corresponding key until obtaining the required value.

10.3 Operating the recorder

The REANIBEX Serie 700 can record the waveform and the events that occur at any time while in operation by pressing the  key located on the front panel. This key also stops the recording. The printing features (delay, speed, heading and paper) will depend upon the configuration of the settings for these parameters. Printing speed is a parameter that can be changed while the recorder is printing. Whenever the printing speed is changed, an event will be printed with the new selected speed.

In addition, the biological signals (ECG and/or pleth waveform) will print all the events that occurred: A change in the operating mode, lead changes, alarm signals, application of filters to the signal, changes in alarm limits, user guide messages for Semi-Automatic Defibrillator mode, changes in the recording speed, changes in the Pacemaker pacing parameters, events included by the user, energy shocks, etc.



The  key permits automatic recording of all the leads depending upon the patient cable connected. This option only functions in Monitor mode. Four seconds will be printed in each

one of the leads and during the printing, changes in signal sensitivity can be made. The  key stops the recording in all of the leads.

If an alarm signal occurs while printing all the leads, an event will be printed as soon as the alarm occurs, indicating the type of alarm, and the recording of the leads will continue.

This function is not active when the VT/VF alarm is activated, when an alarm signal is being printed, or when the report or the utilization trends are being printed. If the VT/VF alarm is activated and this key is pressed, the message "**DISARM VT/VF ALARM**" will appear.

Both in freeze-hold mode and when the utilization performance report is being viewed or when the alarms are being changed, all the leads can be recorded.

When the signal is frozen on-screen (the  key has been pressed) and the print key  has been pressed, the 5 seconds prior to freezing will be printed. Printing in this mode will always be carried out at a speed of 25 mm/sec.

When the device detects an error in the recorder (lack of paper, the door of the recorder is open, or an error in the recorder) this icon will be displayed on-screen whenever the print key is pressed. This icon will disappear when the error is resolved. If the print key is pressed when the recorder is in error, this icon will blink.

The REANIBEX Serie 700 also prints both the utilization performance report and the HR and SpO2% trends (only for devices with this option). Printing this information will always be carried out at 25 mm/sec.

When viewing the utilization performance report screen, if the print key on the front panel is pressed, a recording of all the incidences that occurred from when the device was switched on until this moment is printed:

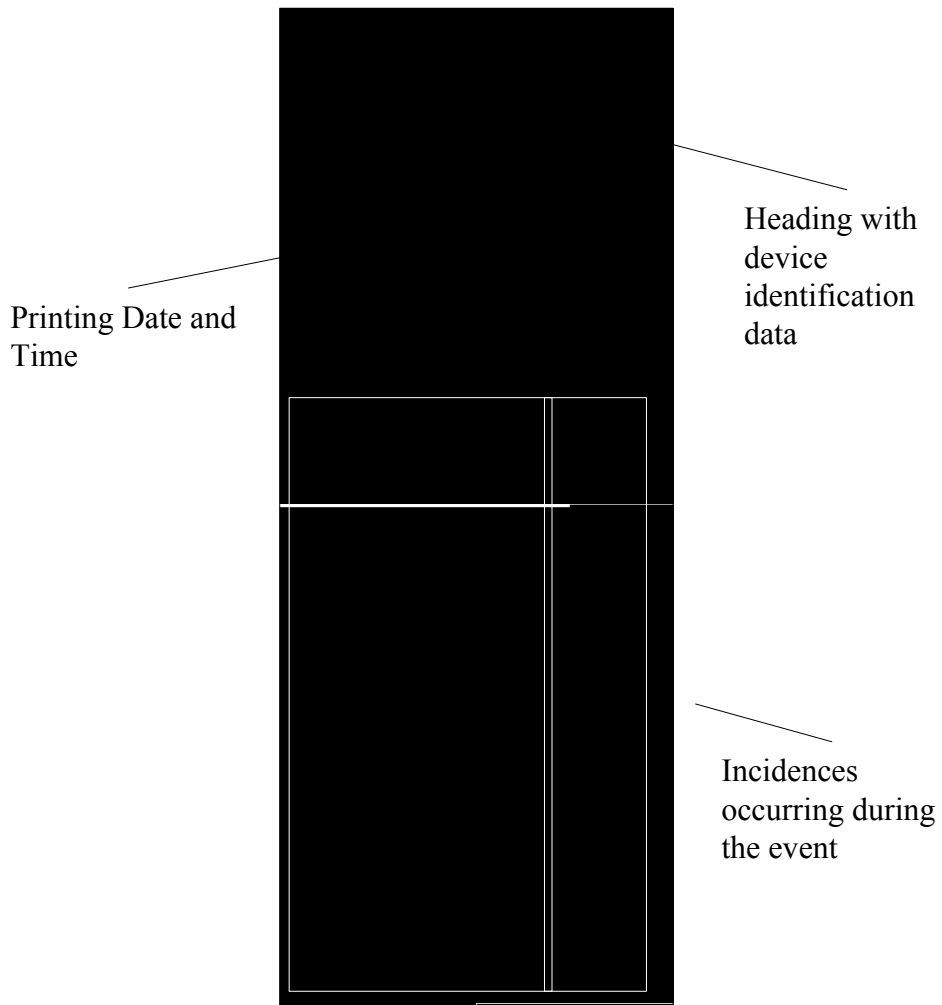

In addition, the HR and SpO2 trends can be printed by pressing the print key when the above mentioned screen is being viewed:

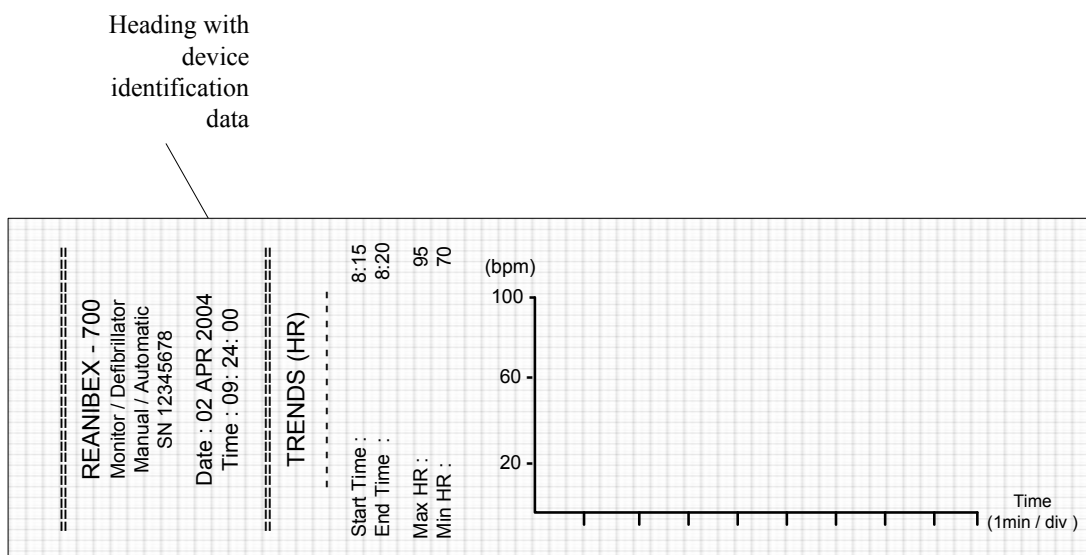

11. Configuration Mode

11.1 Description

Access to the CONFIGURATION MODE is obtained by switching on the device while keeping the MENU  key, located in the lower part on the front panel of the device, pressed down. If there is no key pressed down when the device is switched on, it will start up in the normal manner.

The menus displayed allow the device's functions to be configured in the different operating modes and the user interface can also be configured, that is, the layout of the screen that will be presented to the user.

By entering in this mode, data relating to the device can be accessed (serial number, manufacturing date, history, etc.), as well as making the device perform different self-tests in order to detect possible errors.

From this Configuration Mode, for those devices that have this option, the user can print events/incidences relating to a patient, including the associated ECG signal that are stored in the Compact Flash card.

In order to prevent unwanted changes to the configuration parameters of the device, access to adjust them is effected by means of a passcode. In this way, only authorized users will be able to change them. In addition, when the effected changes are ready to be stored, the user must exit all the sections until reaching the main menu, where the user is then asked if he/she wants to put the new settings into effect. If the device is turned off without the changes in the modifications being accepted, no changes whatsoever will be made in the parameters.

To navigate through the different options displayed, the four keys located just below the device's screen are used. In the lower part of the screen, just above each key, the function it carries out is shown. Thus, the function of the keys can change in each screen.







The symbol options that can appear in the keys are:



Allows navigation through the different menu options



Accesses the selected option

	Go back to the previous menu
	Go forward to the following item
	Go back to the previous item
	Decreases the value of the parameter
	Increases the value of the parameter
	Prints the information displayed on-screen
	Accepts the on-screen changes that were made

NOTE: In the explanation of the parameters that form a part of the device configuration, the value indicated in parentheses during its explanation indicates the value that the parameter should take in order to operate properly with the indicated function.

11.2 Main Menu

Once these options have been accessed, the MAIN MENU is displayed on-screen and consists of the following options:

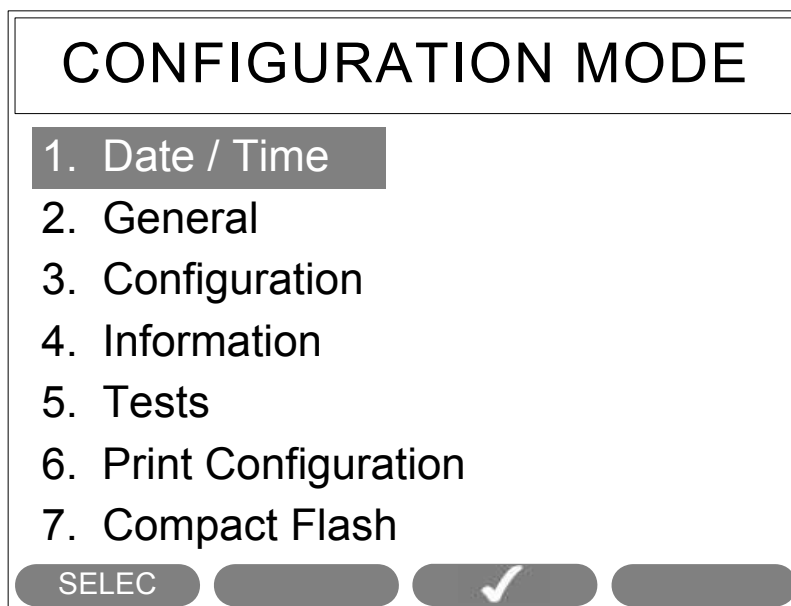

By using the **SELEC** key, the user can navigate from one option to another. The function that each of the keys acquires on the different screens is displayed just above it.

The selected option is displayed in reverse video, and by pressing the  key, this option is accessed.

Each of the options available on this menu is described below:

11.3 Date / Time



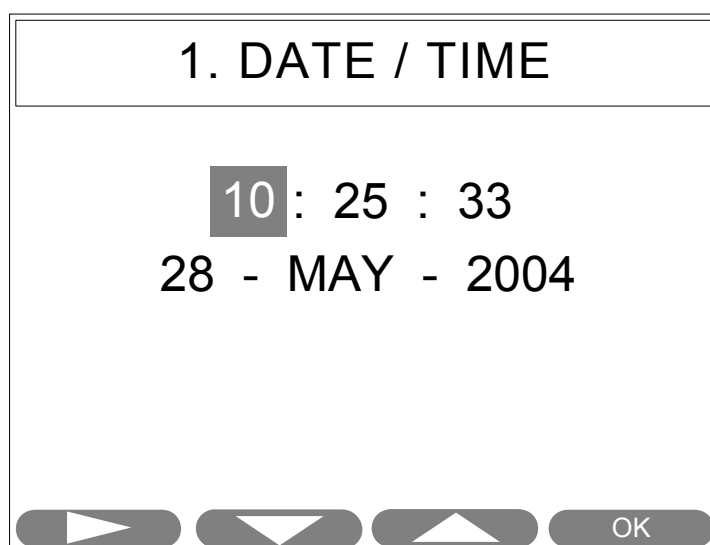

This menu option allows the settings for the real time clock and the date to be configured and changed.

The device's clock will be the reference for the events that occur during the incident, that is, each event will have two interrelated reference times: one that takes the real time clock (the real time) as a reference and the other that takes the time since the start-up of the device as a reference.

The screen displayed on selecting this option is:



The element to be modified is displayed on this screen in reverse video, and by using the keys located in the lower part of the screen, the value of this element can be changed.

The  key allows the user to go forward to the following element that need to be modified and the  and  keys change the value of this element. Once the date and the time have been set, the user can exit this screen by using the  key which accepts the effected changes.

11.4 General

The parameters within the GENERAL submenu not only enable the configuration of the user interface parameters, but also the notch filter that will be applied to the signal as well.

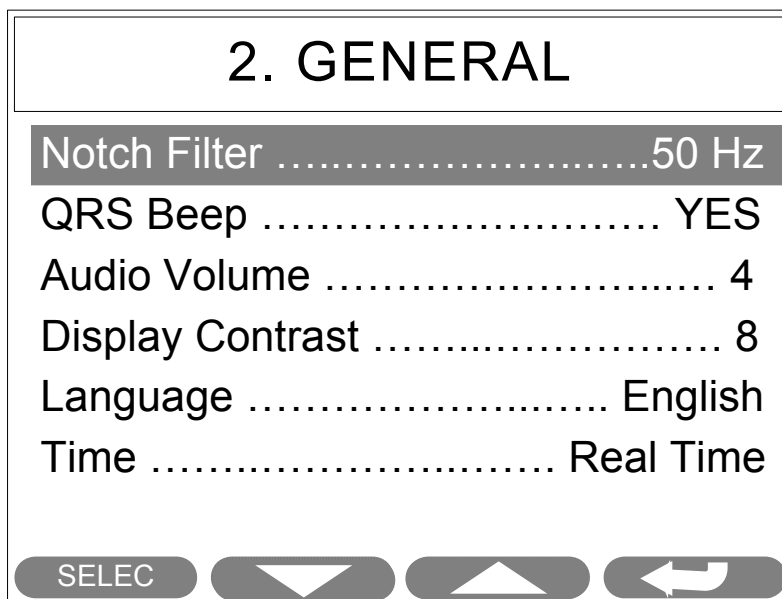

Access to and modification of these parameters is unrestricted and does not require a passcode:

- 1- NOTCH FILTER – It allows the user to select the option of whether or not a notch filter should be applied to the entry ECG signal and, if appropriate, the center frequency which will depend upon the country where the device is used. The values that can be assigned to this parameter are:
 - 50 Hz - The applied notch filter is centered at 50 Hz
 - 60 Hz - The applied notch filter is centered at 60 Hz

- 2- QRS BEEP – It allows the user to decide whether or not the device will emit a beep with each QRS detected. The values that can be assigned to this parameter are YES/NO.
The value of this parameter is set at the start-up of the device and it can also be changed during normal operation of the device.
- 3- AUDIO VOLUME - This parameter relates to the sound intensity when the messages are emitted. There are 8 available levels with the maximum volume being 8.
As the numerical value of this parameter is changed, the device emits a beep corresponding to the intensity of the selected level.
As in the previous case, the value of this parameter can be modified during normal operation of the device.
- 4- DISPLAY CONTRAST - Allows the contrast of the device screen to be adjusted to facilitate proper viewing in different environments in which the lighting can vary. The device has 16 levels of contrast available and as this parameter is adjusted, the screen adopts the appearance that it acquires.
As in the previous case, the value of this parameter can be modified during normal operation of the device.
- 5- LANGUAGE - This option allows the language to be selected for emitting on-screen and voice prompt messages.
The device has the option of functioning in four different languages, selectable by the user.
- 6- TIME - This option allows the user to configure whether the time visible in the top part of the device operating in normal mode is the real time (REAL TIME) or the time since start-up of the device (ON-TIME).



Once the parameters have been modified, by pressing the  key, the user returns to the main menu.

11.5 Configuration

This menu includes all those parameters that determine the functioning of the device. Access in order to change these parameters requires a passcode to be entered, thus preventing unauthorized persons from modifying the values of the abovementioned parameters and therefore the operation of the device.

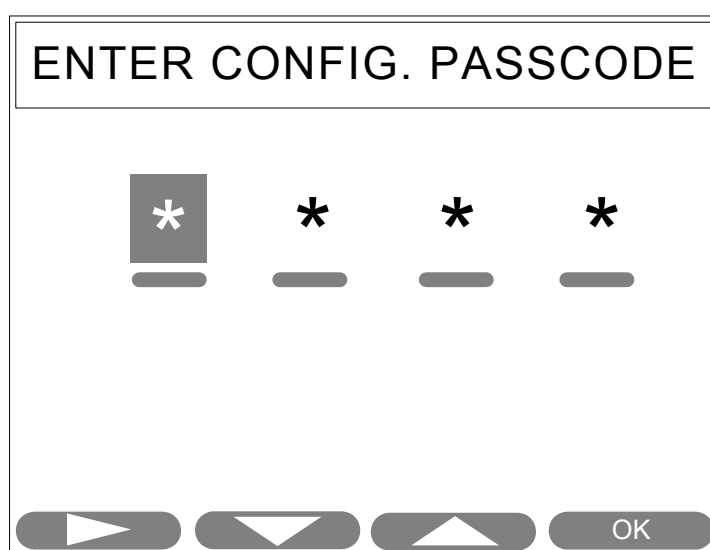
When this option is selected in the main menu, a screen appears that requests a passcode:



The  key allows the user to navigate through the different digits that make up the passcode, whereas the  and  keys change these numerical values.

If the passcode is not entered correctly, the user cannot gain access to the option and in consequence, parameter changes cannot be effected. The default digits for this passcode are 0 0 0 0, which can be subsequently modified.

As soon as the password has been correctly entered, the following screen appears:

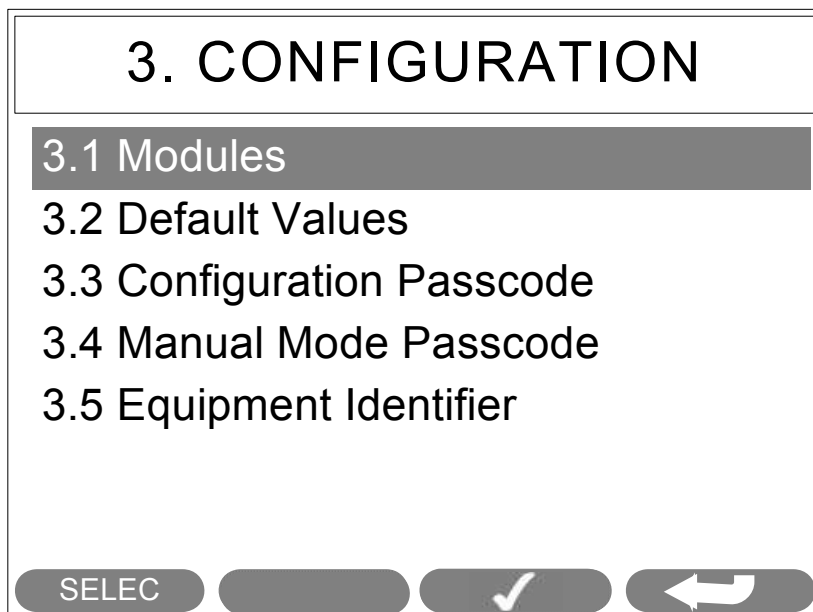

Each of the options included in this menu is explained below:

11.5.1 Modules

This option allows the user to configure the operation of each of the device modules, with modules being defined as the different modes in which the device can operate: Monitor, Manual Defibrillator, Automatic Defibrillator, Pacemaker and Recorder.

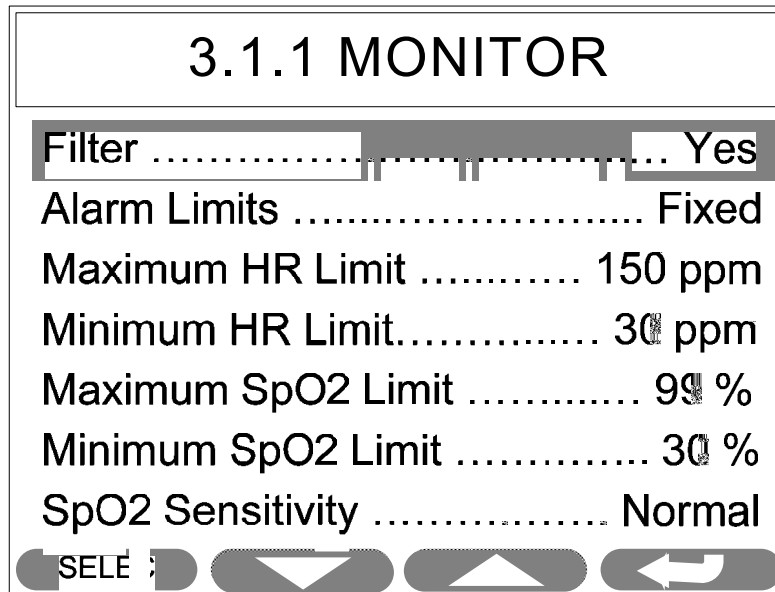

11.5.1.1 Monitor

The options included in this screen allow the user to configure the operation of the device, when functioning in Monitor mode. The parameters that can be modified within this option are:



- 1- **FILTER** – A configuration that allows a muscle movement filter (YES) to be applied by default to the signal or not (NO). The muscle movement filter has a bandwidth at 0.67 – 40 Hz.
The value of this parameter is set at the start-up of the device and it can also be changed during normal operation of the device.
- 2- **ALARM LIMITS** – This parameter is used to indicate how to manage the storage of the changes made to the alarm limits. The possible values for this are:
 - **FIXED** – Each time the device is switched on, the set values at start-up are the limits indicated in the configuration. If they are modified during normal operation, the abovementioned limits are not stored in the configuration.
 - **PROGRAMMABLE** - The device recalls the limits values when the device is switched off, in such a way that if during operation the alarm limits are changed, these values are also stored in the configuration.
- 3- **MAXIMUM HR LIMIT** – This parameter serves to set the maximum Heart Rate (HR) limit at start-up and it can also be changed during normal operation of the device. This parameter can vary from 30 to 300 bpm and it changes in increments of 1 bpm.
- 4- **MINIMUM HR LIMIT** – This parameter serves to set the minimum Heart Rate (HR) limit at start-up and it can also be changed during normal operation of the device. This parameter can vary from 30 to 300 bpm and it changes in increments of 1 bpm.

- 5- MAXIMUM SpO2 LIMIT – This parameter serves to set the maximum Oxygen Saturation (SpO2) limit at start-up and it can also be changed during normal operation of the device. This parameter can vary from 85 to 100 % in increments of 1%.
- 6- MINIMUM SpO2 LIMIT – This parameter serves to set the minimum Oxygen Saturation (SpO2) limit at start-up and it can also be changed during normal operation of the device. This parameter can vary from 85 to 100 % in increments of 1%.
- 7- SPO2 SENSITIVITY – This parameter allow selecting a sensitivity mode for the pulseoximeter. This parameter can have three different values:
 - MAXIMUM – This mode should be used for the sickest patients, where obtaining a reading is most difficult. This mode is designed to interpret and display data for even the weakest of signals. This mode is recommended during procedures and when clinician and patient contact is continuous.
 - NORMAL – This mode provides the best combination of sensitivity and probe-off detection performance. This mode is recommended for the majority of patients.
 - APOD (Adaptive Probe Off Detection) – This mode is the least sensitive in picking up a reading on patients with low perfusion but has the best detection of probe-off conditions. This mode is useful for patients that are at particular risk of the sensor becoming detached (such as pediatric patients).

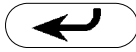
The  key allows the user to navigate through the different parameters on this screen, whereas the  and  keys change their values. Once the values have been changed to the required values, the user can press the  key to return to the previous menu (3.1 Modules).

11.5.1.2 Manual Defibrillator

The options displayed in this section allow the user to configure the functioning of the device, when operating in Manual Defibrillator mode.

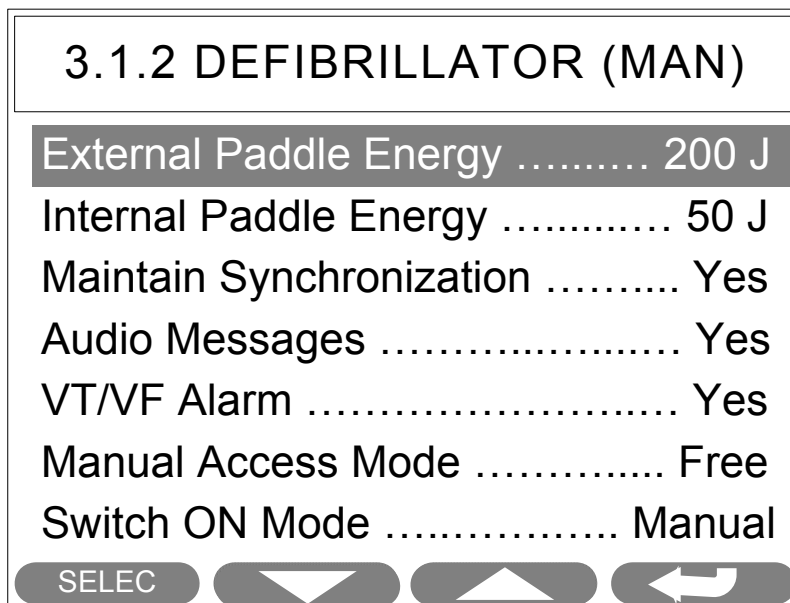

- 1- EXTERNAL PADDLE ENERGY – Selects the energy level at start-up when operating in Manual Defibrillator mode with external paddles (reusable or single-use). The values that can be assigned to this parameter are: 1 - 2 - 3 - 5 - 7 - 9 - 10 - 15 - 20 - 30 - 50 - 70 - 100 - 125 - 150 - 200 Joules.
- 2- INTERNAL PADDLE ENERGY – Selects the energy level at start-up when operating with internal paddles in Manual Defibrillator mode. The values that can be assigned to this parameter are: 1 - 2 - 3 - 5 - 7 - 9 - 10 - 15 - 20 - 30 - 50 Joules.
- 3- MAINTAIN SYNCHRONIZATION – This parameter is used to decide whether if after performing a synchronized shock, synchronization is maintained (YES) or whether it needs to be activated again (NO).
- 4- AUDIO MESSAGE – This parameter is only available in devices that have Automatic Defibrillator mode, and it allows the user to determine if voice prompt messages should be emitted when operating in manual mode in addition to the on-screen messages (YES), or if, on the contrary, the messages will appear only on-screen (NO).
- 5- VT/VF ALARM – This parameter is only available in devices that have Automatic Defibrillator mode, and allows the user to determine whether the VT/VF alarm should be active (YES) at start-up, or on the contrary, whether it should not be active (NO).

- 6- 7- SWITCH-ON MODE – This option is only available in devices with Automatic Defibrillator mode and it allows the user to determine whether the device will operate in Manual Defibrillator mode (MANUAL) at start-up or in Semi-Automatic Defibrillator mode (AUTOMATIC).
- 7- MANUAL ACCESS MODE – This parameter is only valid in devices that have Automatic Defibrillator mode and allows the user to set the access mode to Manual Defibrillator mode. The functions that can be assigned are:
- UNRESTRICTED - There is no restriction for access to the Manual Defibrillator mode.
 - PASSCODE - Access to the Manual Defibrillator mode requires a passcode to enter.
 - PROHIBITED - Access to Manual Defibrillator mode is not authorized so that the device only operates in Automatic Defibrillator mode.

If the configuration is such that the starting mode of the device is MANUAL, access to the Manual Defibrillator mode must be UNRESTRICTED.

NOTE 1: Although the device starts up in the Automatic Defibrillator mode, it can change over to Manual Defibrillator mode providing that the configuration options allow it to do so.

NOTE 2: In Semi-Automatic Defibrillator mode, only single-use multifunction electrodes can be used for defibrillation, and therefore if the device detects that the reusable internal or external paddles are connected, it will pass automatically to the Manual Defibrillator mode.

11.5.1.3 Automatic Defibrillator

The options included within this submenu allow the user to configure the functioning of the device when operating in Automatic Defibrillator mode. All these parameters will be only available in devices that have Automatic Defibrillator mode available.

The parameters included within this option are:

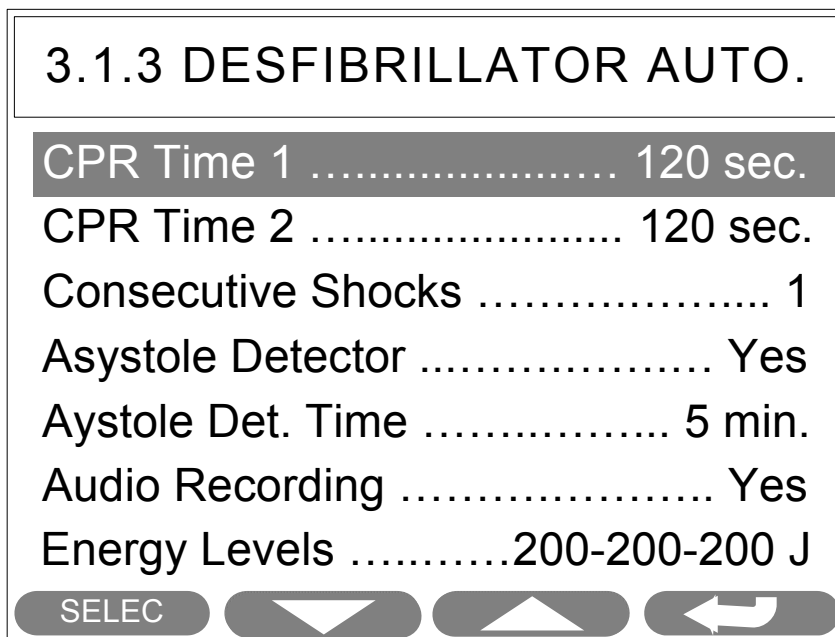

1- CPR TIME 1 – This time relates to the Cardiopulmonary Resuscitation (CPR) time required after the consecutive shocks indicated in the option CONSECUTIVE SHOCKS. The different values that this parameter can assign are: 15, 30, 45, 60, 120 and 180 seconds and OFF.

The default value for this parameter, according to the 2005 ILCOR (International Liaison Committee on Resuscitation) recommendations and the ERC (European Resuscitation Council) recommendations is 120 seconds.

2- CPR TIME 2 – This time relates to the CPR time after the SHOCK NOT ADVISED warning from the AED, that is, the device has detected a rhythm that cannot be defibrillated. The values that can be assigned to this parameter are: 15, 30, 45, 60, 120 and 180 seconds and OFF.

The default value of this parameter, according to the 2005 ILCO and ERC recommendations, is 120 seconds.

NOTE: When the value of the CPR time is OFF, once the device enters into CPR time, the user must press the ANALYSIS key of the front panel once again to initiate a new analysis.

3- CONSECUTIVE SHOCKS – This parameter allows the user to set the maximum number of consecutive shocks that are delivered to the patient, before the CPR1 (CardioPulmonary Resuscitation Time) pause if there is a shockable rhythm. The values that can be selected are 1, 2, 3 and 4 shocks.

The default value of this parameter, according to the 2005 ILCOR and ERC recommendations, is 1 shock.

- 4- ASYSTOLE DETECTOR – This option allows the user to activate the ASYSTOLE DETECTOR.

When this option is active, a time interval (between 4 and 60 minutes) must also be configured during which the device will detect asystole, before emitting an on-screen indicator message and a voice prompt message as well.

- 5- ASYSTOLE DET. TIME – This is the time during which the device is going to detect asystole before emitting an indicator message. This parameter can vary from 4 to 60 minutes in increments of 1 minute.

- 6- AUDIO RECORDING – When this option is active (YES) ambient sound occurring during the utilization of the device in Automatic Defibrillator mode is recorded. By default this option is deactivated (NO).

- 7- ENERGY LEVELS – This parameter allows the user to set the energy sequence for the consecutive shocks delivered in Semi-Automated Defibrillator mode. The default value of this parameter is 200-200-200 Joules.

11.5.1.4 Pacemaker

The options included in this submenu allow the Pacemaker mode parameters at start-up to be configured.

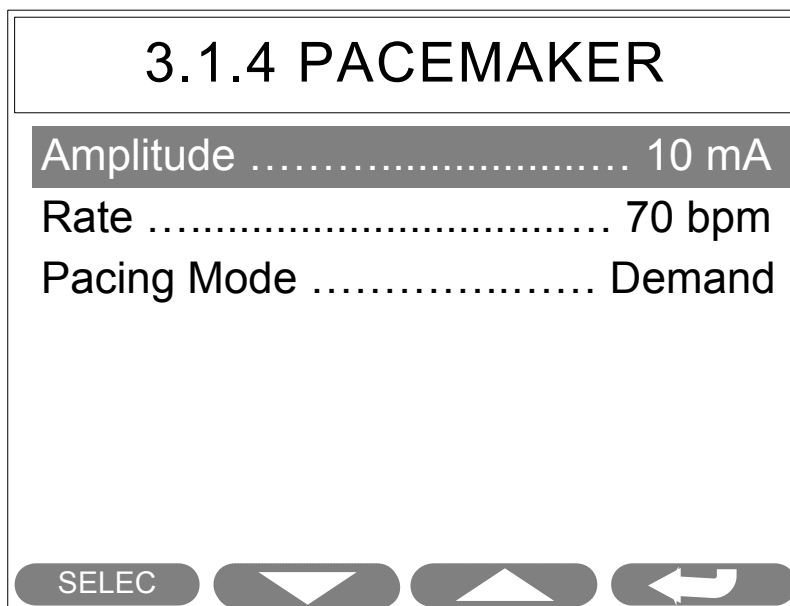

- 1- AMPLITUDE – Indicates the pacing amplitude at the start-up of the Pacemaker mode. This parameter can vary from 0 to 150 mA in increments of 5 mA.
- 2- RATE – Indicates the pacing rate at the start-up of the Pacemaker mode. This parameter can vary from 30 to 180 bpm in increments of 5 bpm.
- 3- PACING MODE – Determines if the pacemaker is going to operate in FIXED mode or in ON-DEMAND mode.

NOTE: These parameters refer only to the operating mode at start-up. During the utilization of the device, these parameters can be changed using the controls available for this purpose on the front panel of the device.

11.5.1.5 Recorder

The options shown in this submenu allow the user to configure the functioning of the device's Recorder:

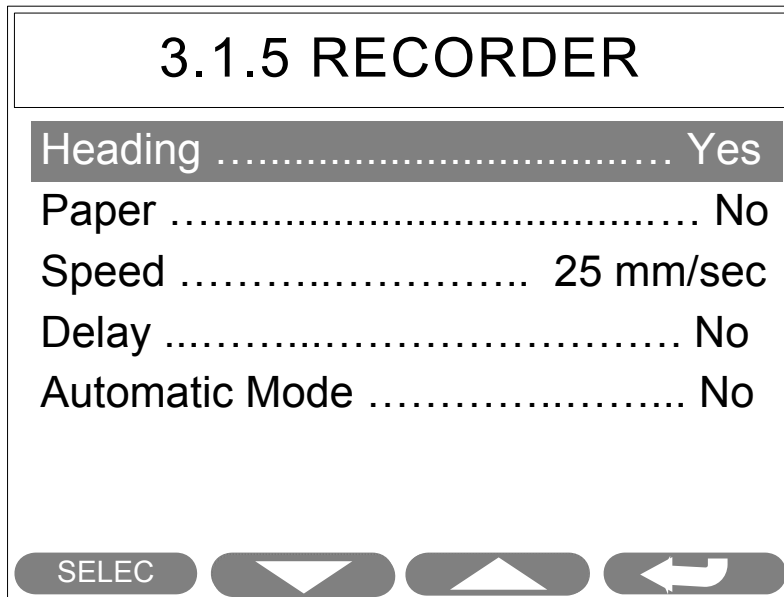

- 1- HEADING – This parameter determines each time that a recording is printed, if the heading will also be printed (YES) or if, on the contrary, only the initial data will be printed (NO).
- 2- PAPER – This parameter determines at the end of the recording, if a blank paper margin appears, so that when the paper detached, the full recording is available (YES), or, on the contrary, the blank paper margin does not appear and when the recording is detached, part of the record will remain under the recorder cover (NO).
- 3- SPEED - Determines the printing speed of the recorder. The values allowed are: 10 mm/sec, 25 mm/sec and 50 mm/sec.
This parameter can be changed while operating the device.
- 4- DELAY – This parameter determines if the recorder will print with an 8-second delay in regards to the signal viewed on-screen (YES), or if, on the contrary, it will print in real time (NO).
This parameter can be changed while operating the device.
- 5- AUTOMATIC MODE – If the recorder is configured so that it operates in automatic mode (YES), each time an alarm is signalled or an energy shock is delivered, the 8 seconds prior to and after the event will be printed.
This parameter can be changed while operating the device.

11.5.2 Default Values

During manufacturing of the device, a configuration is entered comprised of a series of values for each of the parameters which we will call the “Default Values”.

The default values of the different parameters are shown in the following table:

PARAMETER	DEFAULT VALUE
GENERAL	
Notch Filter	50 Hz
QRS Beep	NO
Audio Volume	Level 4
Screen Contrast	Level 8
Language	English
Time	TIME ON
MONITOR	
Filter	YES
Alarm Limits	FIXED
Maximum HR Limit	120 bpm
Minimum HR Limit	50 bpm
Maximum SpO2 Limit	100 %
Minimum SpO2 Limit	90 %
SpO2 Sensitivity	Normal
MANUAL DEFIBRILLATOR	
External paddle energy	200 J
Internal paddle energy	50 J
Maintain synchronization	NO
Audio Message	NO
VT/VF Alarm	NO
Manual Access Mode	UNRESTRICTED
Start-up Mode	MANUAL
AUTOMATIC DEFIBRILLATOR	
CPR Time 1	120 seconds
CPR Time 2	120 seconds
Consecutive Shocks	1
Asystole Detection	NO
Asystole Det. Time	4 minutes
Audio Recording	NO
Energy Levels	200-200-200 Joules

PACEMAKER	
Amplitude	0 mA
Rate	60 ppm
Mode	DEMAND
RECORDER	
Heading	YES
Paper	YES
Speed	25 mm/sec
Delay	NO
Automatic Mode	YES
OTHER	
Configuration Access Passcode	0000
Manual Mode Access Passcode	0000
Device ID	0123456789 ABCDE

When the option DEFAULT VALUES is accessed, a screen appears that requests confirmation before loading the parameters. Once confirmed, by selecting the option YES and pressing the



key, the values are loaded for these parameters.

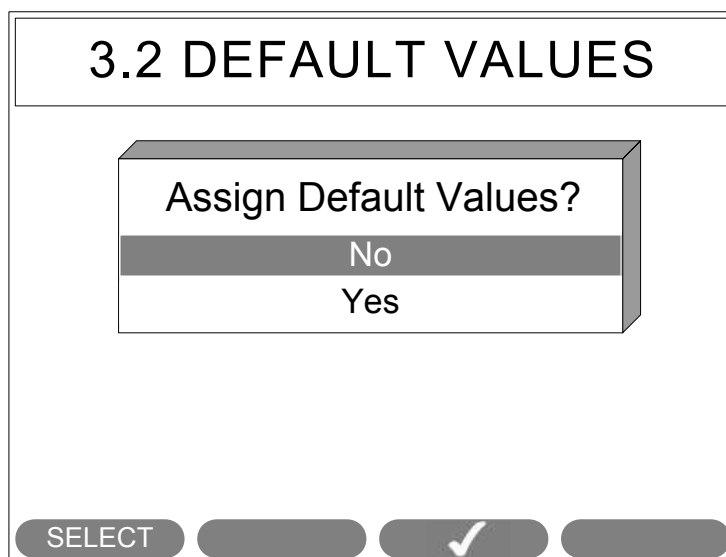



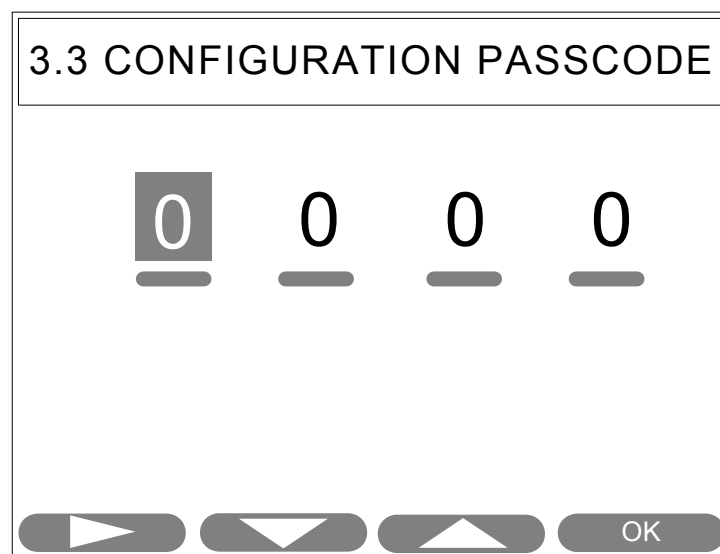

11.5.3 Configuration Passcode

From this configuration option, the user can change the passcode that provides access to the configuration parameters. This code prevents unauthorized persons from having access to the parameters that govern the functioning of the device and from modifying them.

When this option is accessed the following screen appears:



The default value of the configuration access passcode is 0 0 0 0, which can be changed using this screen. The  key allows the user to navigate through the different digits that make up the passcode, whereas the  and  keys change these numerical values. Once the digits of the required passcode have been obtained, by pressing the  key, this code is stored as a configuration parameter.

11.5.4 Manual Mode Passcode

For devices that have the Automatic Defibrillator option, access to the manual mode can be unrestricted, restricted by a passcode or prohibited. If a passcode must be entered, the digital values can be defined using this option.

When this option is accessed, the screen displayed is the same as the Configuration passcode option and the steps to change the code are similar to the previous case.

11.5.5 Equipment Identifier

The EQUIPMENT IDENTIFIER is made up of a 16-character string which can identify the device in use. Its default value is the serial number of the device, but it can be changed by the user.

This identifier is one of the data that is included when an incident is downloaded, so that for every incident, the device that recorded the event can be identified.

When this option is accessed, a screen is displayed that allows the user to modify this identifier using the keys located below the screen:

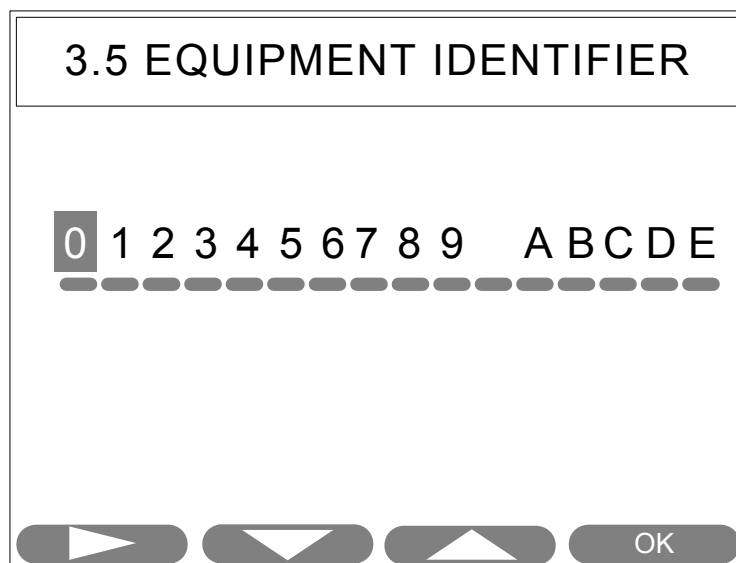

The steps to change the characters that make up the device identifier is similar to that explained in the previous section for the passcodes.

11.6 Information

This section of the configuration collects information relating to the device, its performance and the self-tests that the device performs in order to check that it is operating properly.

11.6.1 Device Information

In this section, information relating to the device is given. When this option is accessed, a screen is displayed that contains the following information:

4.1 DEVICE INFORMATION	
Model	: Reanibex 700
SN	: 123456789
SW Version	: 1.0
Identifier	: 0123456789 ABCDE
Manuf. Date	: 10/02/2004
PRESS ANY KEY TO EXIT	

- 1- MODEL – This parameter indicates the device model.
- 2- SN – Indicates the serial number of the device assigned during manufacturing.
- 3- SW VERSION – Indicates the Software version included in the device.

- 4- IDENTIFIER – This is the device identifier (See Section 11.5.5). It can be modified by the user.
- 5- DATE OF MANUFACTURE – Indicates the date on which the device was manufactured.

11.6.2 History

In this screen, information relating to the utilization of the device is displayed.

4.2 HISTORY	
Last Utilization	: 7 MAY 2004
Last Shock	: 22 APR 2004
Last HW Test	: 10 FEB 2004
Max Temp	: 35 ° C
Min Temp	: 10 ° C
Press any key to exit	

- 1- LAST UTILIZATION – Date the device was last used, that is, the last time it was switched on.
- 2- LAST SHOCK – Date on which the last defibrillation shock was delivered.
- 3- LAST HW TEST – Date of the last Hardware test carried out, meaning as performed by the user from the configuration.
- 4- MAX TEMP – Maximum temperature in degrees centigrade, to which the device has been submitted.
- 5- MIN TEMP – Minimum temperature in degrees centigrade, to which the device has been submitted.

11.6.3 Device Test Results

This screen collates the date, time, type and result of the last 30 self-tests performed by the device.



The values the TYPE column are assigned are:



- START UP- Tests carried out during the start-up of the device
- MANUAL – A test carried out by the user using the configuration options
- PATMON - Test relating to the patient's monitor
- DEF – A test responsible for verifying the component corresponding to the defibrillator
- PMK – A test responsible for verifying the operation of the Pacemaker (only for devices with this option)
- PLS – A test responsible for verifying the operation of the pulse oximetry module (only for devices with this option)
- PRNT – A test that verifies the operation of the device recorder
- COPRO – A test responsible for checking the operation of the device's co-processor (only for devices with the Automatic Defibrillator option)

If the result of the self-test was correct, OK appears in the RESULT column, whereas if any error exists E - XXX appears, where X indicates the code of the error detected.

The screen displayed on accessing this option is as follows:

4.3 TEST RESULTS			
			PAG: 1 / 2
DATE	TIME	TYPE	RESULT
22 MAY 04	15:00	STARTUP	OK
23 MAY 04	15:00	PLS	OK
01 JUN 04	09:00	MANUAL	E- 72
01 JUN 04	15:23	MANUAL	E- 56
15 JUN 04	20:00	MANUAL	OK
03 JUL 04	12:36	MANUAL	OK
03 JUL 04	12:38	STARTUP	OK
26 JUL 04	12:36	MANUAL	OK
29 AGO 04	12:36	STARTUP	OK
03 SEP 04	12:36	MANUAL	OK

PRINT   

By using the  and  keys, the different pages of the report can be viewed. In the upper part of the screen, the annotation Pag. X/X appears where the second number indicates the total number of pages, and the first number represents the page that is being viewed.

The information displayed on this screen can be printed by the device recorder using the  key located below the screen. The printed report appears as follows:

Printing Date and Time of the self-test results

Heading with device identification data

Date, time, type and result of the last 30 self-tests performs by the equipment

REANIBEX - 700			
Monitor / Defibrillator			
Manual / Automatic			
SN 12345678			
Date : 02 APR 2004			
Time : 09: 24: 00			
DEVICE TESTS			
DATE	TIME	TYPE	RESUL
22MAR04	11 : 20	STARTUP	OK
22MAR04	11 : 20	STARTUP	OK
22MAR04	11 : 20	STARTUP	71
22MAR04	11 : 20	MANU	OK
22MAR04	11 : 20	STARTUP	OK
22MAR04	11 : 20	STARTUP	OK
22MAR04	11 : 20	PLS	81
22MAR04	11 : 20	STARTUP	OK
22MAR04	11 : 20	STARTUP	OK
22MAR04	11 : 20	STARTUP	OK
22MAR04	11 : 20	STARTUP	OK
22MAR04	11 : 20	STARTUP	OK
22MAR04	11 : 20	MANU	OK
22MAR04	11 : 20	STARTUP	OK
22MAR04	11 : 20	STARTUP	OK
22MAR04	11 : 20	MANU	44
22MAR04	11 : 20	MANU	OK
22MAR04	11 : 20	STARTUP	OK
22MAR04	11 : 20	STARTUP	OK
22MAR04	11 : 20	PMK	OK
22MAR04	11 : 20	STARTUP	OK
22MAR04	11 : 20	STARTUP	OK
22MAR04	11 : 20	PLS	OK
22MAR04	11 : 20	MANU	OK
22MAR04	11 : 20	STARTUP	OK
22MAR04	11 : 20	STARTUP	OK
22MAR04	11 : 20	STARTUP	OK
22MAR04	11 : 20	STARTUP	OK
22MAR04	11 : 20	STARTUP	OK
22MAR04	11 : 20	MANU	OK

11.7 Tests

From this section of the configuration, the user can oblige the device to perform tests in order to check its integrity.

The device at start-up and during its operation performs different tests and checks in order to make sure that all the components of the device are operating correctly.

If within a period of 30 days, the device has not delivered any defibrillation shock, when the device is switched on, a warning message will appear recommending that a test be performed. This screen appears for a few seconds and then the device proceeds to normal operation. It is advisable to switch off the device and to switch it on in Configuration mode to access the Test option and perform the appropriate tests.

11.7.1 Hardware Test

This option allows a series of tests and checks to be performed on different components of device such as the control circuits (CPU), the battery indicating its voltage, the power supplies of the device indicating their value, the patient monitor and defibrillation circuits, the co-processor responsible for detecting algorithms, and recording the data in the memory (only for devices with this option), the pacemaker circuits (only for devices with this option), the pulse oximeter (only for devices with this option) and the recorder.

The results are displayed on-screen according to the way the tests are performed. If any error is detected, the corresponding code will be given. If, on the other hand, the results of the tests performed are correct, an "OK" will be displayed on each corresponding screen.

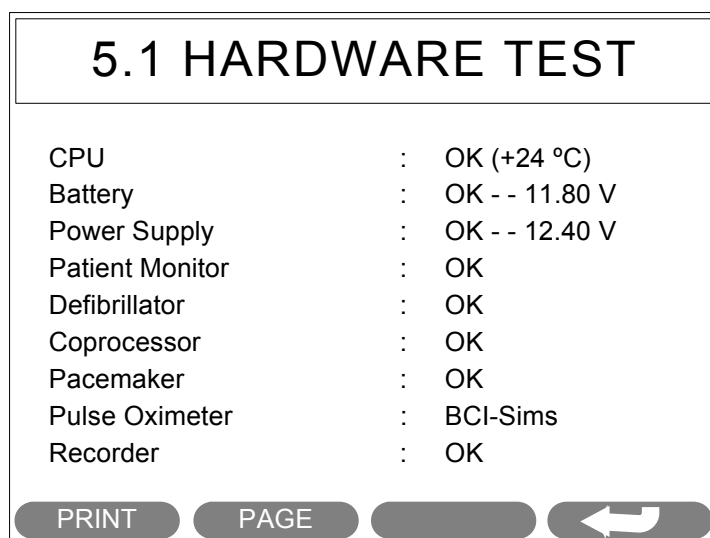

SHOCK HAZARD: Do not connect the defibrillation electrodes during the execution of the hardware test. This connection can result in electrical shocks.

Once all the self-tests included in this section have been concluded, their results can be printed by using the **PRINT** key located below the screen.

REANIBEX 700	HARDWARE TEST	
Monitor / Defibrillator Manual / Automatic	CPU	: OK
SN 123456789	Battery	: No Battery
20 APR 2004	Power Supply	: OK
12 : 23 : 13	Patient Monitor	: OK
	Defibrillator	: E -44
	Coprocessor	: OK
	Pacemaker	: OK
	Pulse Oxymeter	: Sims- BCI
	Recorder	: OK

It is not recommended to perform this Hardware Test more than 5 consecutive times in order to avoid excessive temperatures inside the device. If this test must be performed more than 5 times, it is recommended to switch off the device for a period of at least one hour.

If the "PAGE" key is pressed and the recorder is operative, it will print a test sheet for the purpose of ensuring the recorder prints correctly. The test sheet should appear as follows:

REANIBEX - 700 Monitor / Defibrillator Manual / Automatic SN 123456789 Date : 02 APR 2004 Time : 09: 24: 00 TEST PAGE	LARGE FONT	SMALL FONT
	! " # \$ % & ' () * + , - . / 0 1 2 3 4 5 6 7 8 9 : ; < = > ? @ A B C D E F G H I J K L M N O P Q R S T U V W X Y Z [\] ^ ` A B C D E F G H I J K L M N O P Q R S T U V W X Y Z { } ~ () - = > ≤ ≈ ≠ ≡ √ ∞ ∫ ∑ ∏ ∙ ∘ ∙ ∘ ∙ ∘ ∙ ∘ ∙ ∘ ∙ ∘ ∙ ∘ ∙ ∘ ∙ ∘ ∙ £ ¤ ¥ ¦ § ¨ © ª « ¬ ® ¯ ° ± ² ³ ´ µ · ¸ ¹ º » ¼	! " # \$ % & ' () * + , - . / 0 1 2 3 4 5 6 7 8 9 : ; < = > ? @ A B C D E F G H I J K L M N O P Q R S T U V W X Y Z [\] ^ ` A B C D E F G H I J K L M N O P Q R S T U V W X Y Z { } ~ () - = > ≤ ≈ ≠ ≡ √ ∞ ∫ ∑ ∏ ∙ ∘ ∙ ∘ ∙ ∘ ∙ ∘ ∙ ∘ ∙ ∘ ∙ ∘ ∙ ∘ ∙ £ ¤ ¥ ¦ § ¨ © ª « ¬ ® ¯ ° ± ² ³ ´ µ · ¸ ¹ º » ¼

11.7.2 Accessories Test

This option checks the proper functioning of the accessories connected to the device, meaning the patient cables and paddles.

For paddles, the type is displayed and at the side, a symbol appears that indicates if the paddles are in short circuit (—) or open circuit (_ -).

When this option is accessed, the following screen is displayed:

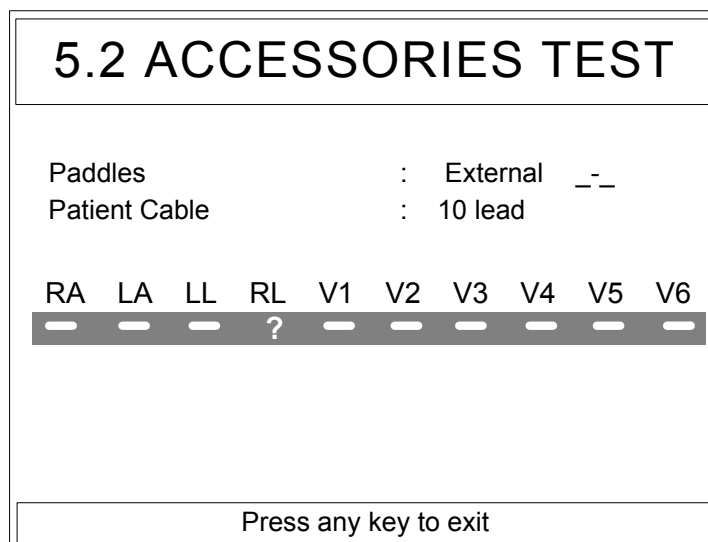

- 1- PATIENT CABLE – Indicates the type of patient cable that is connected the device (4, 5 or 10 lead) at the time the test is performed. If there is no patient cable connected to the device, the words "NOT CONNECTED" will be displayed.
- 2- PADDLES – Indicates the type of paddles that are connected to the device at the time the test is performed: External paddles (EXTERNAL), internal paddles (INTERNAL) or Single-Use paddles (SINGLE-USE). If there are no paddles connected, the word SINGLE-USE will also be displayed.

This Test can also check the proper functioning of the circuit that detects a detached patient lead. In the lower part of the screen an image of the patient cable leads appears. If a cable with less than 10 leads is connected, under the name of the missing lead the symbol "-" appears. If the lead is not connected, the symbol "X" appears below the indicator, and if the lead is connected, the symbol "O" appears.

The symbol "?" always appears in the RL lead since it is the reference. If this lead is not connected, the symbol "X" appears in all the rest of the leads since the connections cannot be checked.

NOTE: If operating with a 4 lead patient cable, when one of the leads is detached, an indicator will signal that they all are detached, since with this type of cable it cannot detect the specific lead which is detached.

11.7.3 Front Panel

This option checks the proper functioning of all the keys and indicators on the front panel. When this option is accessed, a screen is displayed with a graphic representation of the front panel that includes all the keys of the REANIBEX Serie 700. The function keys located below the screen are illuminated. The proper function of these keys is checked on exiting this option, since it is necessary to press any of the function keys to exit.

While in this option, the battery and malfunction indicators will blink a red colour, thus checking the proper function of the latter.

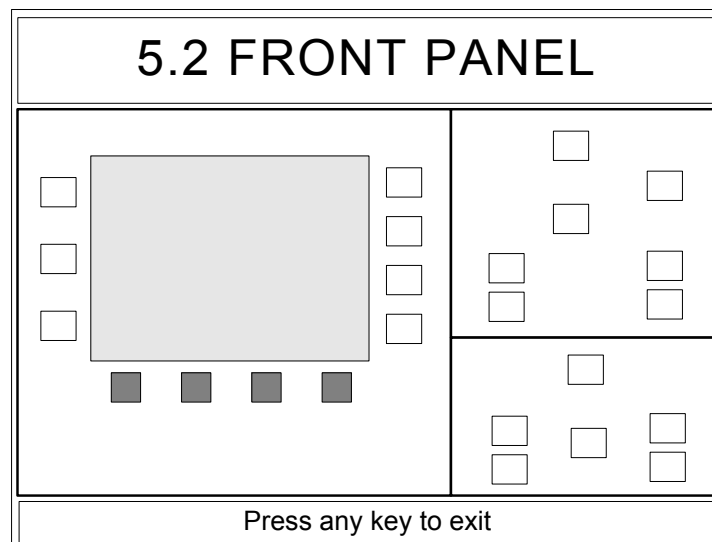

It is an interactive test. When the different keys on the front panel of the device are pressed, their graphic representation on-screen is illuminated and a beep is emitted. If this key has an associated LED indicator, it is illuminated during the time that the key is held pressed.

11.7.4 Paddle Interface

This test, like that of the previous section, is an interactive test that checks the function of the interface with the reusable external paddles. On accessing this option, a graphic representation of the paddles, with all of its keys, is displayed.

If this option is accessed without having reusable external paddles connected to the device, the message "NOT CONNECTED" will appear. In order to be able to perform the test, the user must exit the option, connect the reusable external paddles to the device, and enter once again.

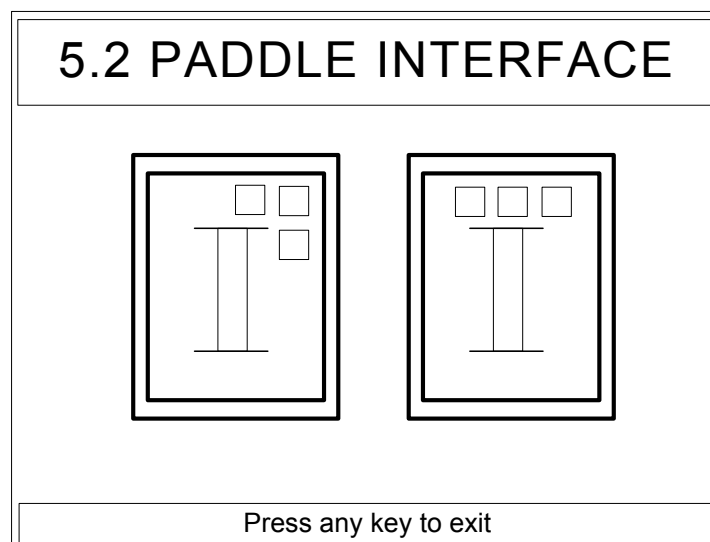

When the different keys of the paddles are pressed, its position is illuminated on-screen.

11.8 Print Configuration

This option allows the user to print the configuration of the device, showing the values of all the parameters. The user must confirm that he/she wants to print the configuration.

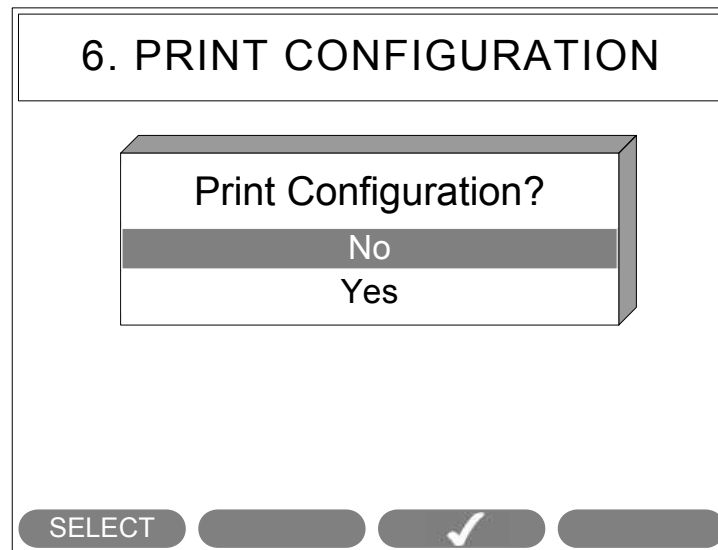

Once accepted, the printing of the configuration starts, showing a progress bar on-screen, indicating the printing status.

All the configuration parameters are printed on one strip of paper, laid out in the same way that they appear in the menu options.

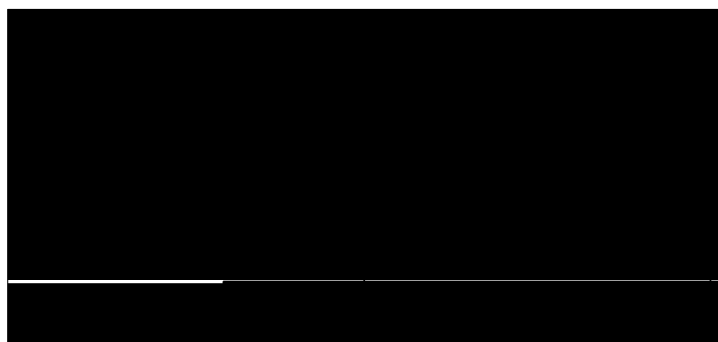
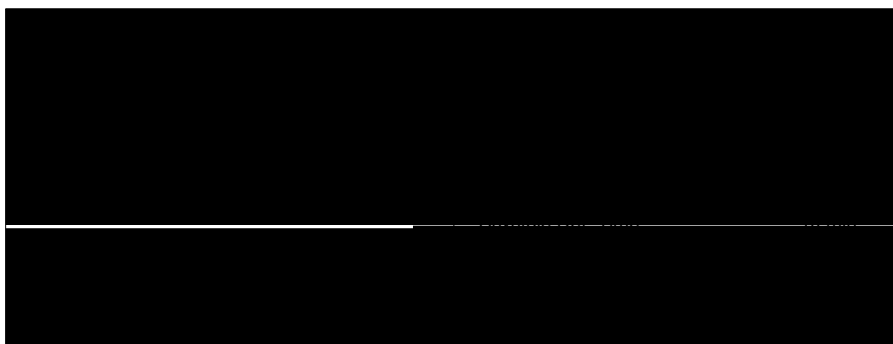
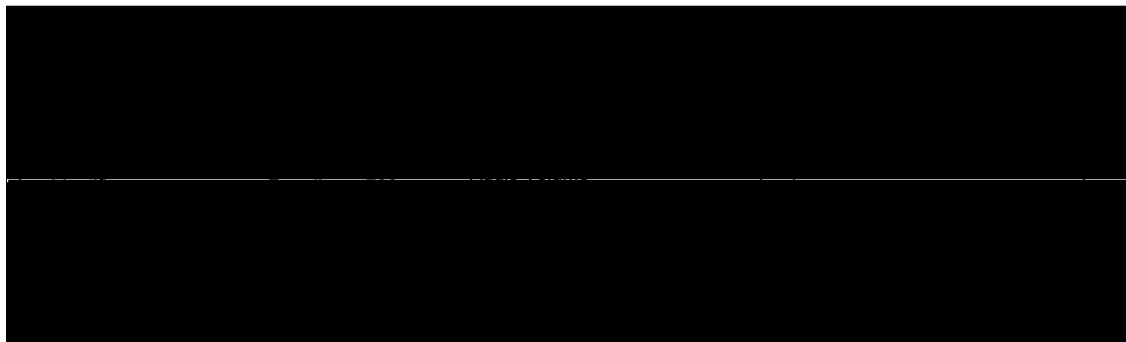

11.9 Compact Flash

The REANIBEX Serie 700 devices that have the Semi-Automatic Defibrillator option can store the information, relating to the ECG waveform and to the incidences that occurred while operating the device in a removable Compact Flash memory card.

The device only accepts memory cards of capacity equal to or greater than 16 MB. In a 16 MB card, up to 2 hours of continuous ECG signal can be stored, along with the audio and the events associated with it.

In addition to the ECG signal, the last 100 events/incidences are stored in the card, along with the corresponding ECG signal, grouped according to the episode (patient) to which they belong. Each episode within the Compact Flash card is identified by the date and time of its onset; episode being defined as from the time the equipment is switched on until it is switched off.

11.9.1 Information

This section allows the user to view the information relating to the Compact Flash memory card that is inserted into the device.

When this option is accessed, a screen is displayed that contains the following information:

- 1- TOTAL SPACE – Indicates the total storage capacity of the memory card, in Megabytes (MB), that is inserted into the device.
- 2- FREE SPACE – Indicates the free space remaining in the memory card for storing new episodes. This data is also expressed in Megabytes (MB).
- 3- EPISODES (NO AUDIO) – Indicates the total number of episodes that are stored in the memory card.
- 4- EPISODES (AUDIO) – Of all the episodes stored in the memory card, this data indicates those which have audio.
- 5- NO. EVENTS – This parameter relates to the number of events that are recorded in the memory card. The maximum number of events that can be registered is 100.

7.1 INFORMATION

Total Space :	128 MB
Free Space :	100 MB
EPIS (Audio) :	85
EPIS (No Audio) :	21
No. of Events :	3

Press any key to exit

11.9.2 Printing Events

This section allows the user to directly print from the recorder the events/incidences stored in the Compact Flash memory card.



The different events are grouped according to the episode (patient) to which they belong, each one being identified by the date and time of its onset. When this option is accessed, a list is displayed of all the episodes recorded in the memory card that have an associated event:

7.2 PRINT EVENTS

PAGE: 1 / 2

EVENT	DATE	TIME
EPI040422150010	22 MAY 04	15:00:10
EPI040422172225	22 MAY 04	17:22:25
EPI040423093600	23 MAY 04	09:36:00
EPI040426074539	26 MAY 04	07:45:39
EPI040426105902	26 MAY 04	10:59:02
EPI040426161110	26 MAY 04	16:11:10
EPI040427224629	27 MAY 04	22:46:29
EPI040427000953	27 MAY 04	00:09:53
EPI040428092715	28 MAY 04	09:27:15
EPI040429121010	29 MAY 04	12:10:10

SELECT

The **SELECT** key allows the user to select the different episodes displayed on-screen and by using the  key, the screen advances to the following page with the episodes stored in the memory card. When the last page is reached, if this key is pressed the first page is displayed once again. In the upper part of the screen, the annotation Pag. X/X is displayed where the second number indicates the total number of pages, and the first number represents the page that is being viewed. The  key allows the user to exit this screen and return to the previous one and the  key accesses the episode and displays a screen with all the events of this episode:

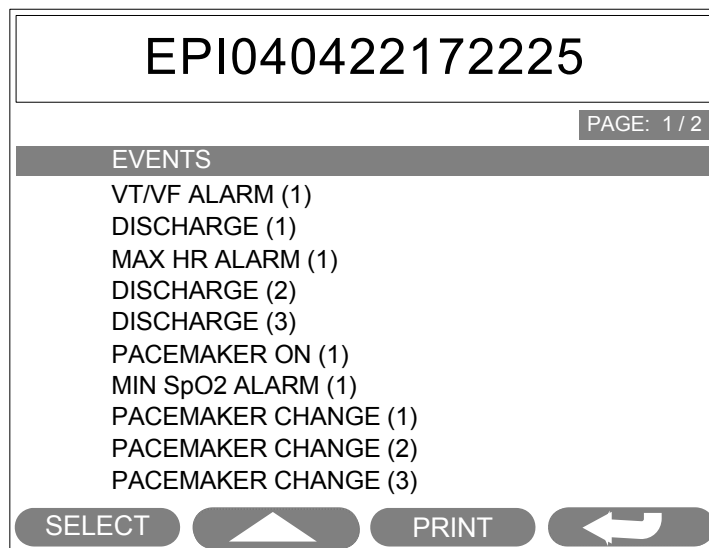

The steps for navigating through these screens are similar to those explained in the previous case. Once the required event has been selected, by using the **PRINT** key it is printed by the device recorder.

The information that is printed contains a heading with the most representative data of the event and 8 seconds prior to and after said event.

If more information is required about the stored events, consult Section "**12. Managing and Reviewing Data**".

11.9.3 Deleting Episodes

This Configuration option can delete the information held in the Compact Flash memory card that has been recorded by the REANIBEX Serie 700. Before proceeding to deleting the information, confirmation that the user does, in fact, want to delete the information will be requested.

Deleting the Compact Flash card is a complete and irreversible process, so that once the operation is finished, the deleted information can never be recovered.

11.9.4 Formatting

This menu option allows the user to format the memory card. Formatting is an irreversible operation that also includes the deletion of all of the information contained in the memory card, regardless of whether this has been created or not by the REANIBEX Serie 700.

Before proceeding to this operation, the device requests the user for confirmation that he/she really wishes to carry out this operation.

11.10 Changing the Configuration Options

To change the Configuration Options, the device must be in the CONFIGURATION mode.

Access to this operating mode of the device is obtained by pressing the  key and holding it down which starts up the device.

In order to modify any one of the parameters, the user must gain access to them, using the configuration buttons, and once the required parameter has been modified, he/she exits from this parameter until reaching the main screen of the Configuration mode.

If changes are made to any of the operating parameters, the user will be asked if it is required put these changes into effect, before exiting from the Configuration menu:

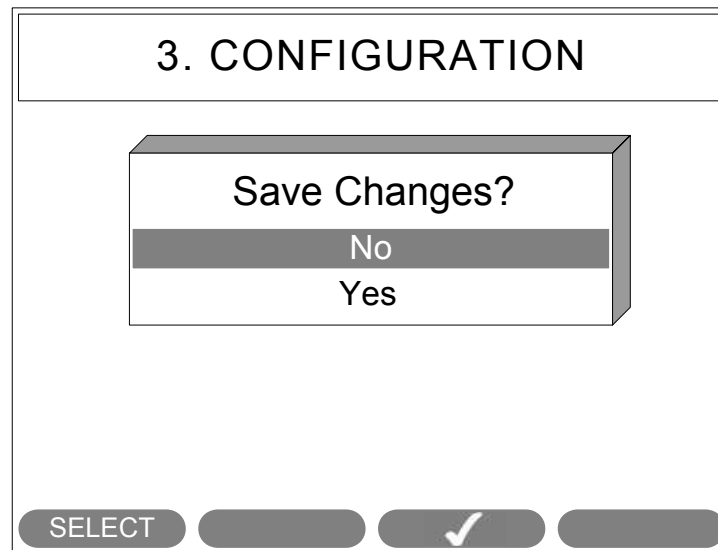

Once this screen is displayed, by selecting the option "Yes" all of the changes carried out will be stored in the device's memory, making them effective.

Blank sheet

12. Managing and Reviewing Data

The REANIBEX Serie 700 has the capacity to store the actions performed with the device in an external Compact Flash memory. These actions consist of the continuous ECG signal along with the corresponding events (change of lead, alarm signals, entering events, etc.). The Heart Rate values and the pulse oximetry value (only for devices with this option) are also periodically stored.

When the device operates in Automatic Defibrillator mode, the audio of both the device and the surrounding setting can be recorded.

The quantity of stored information depends upon the capacity of the memory card inserted into the device. THE REANIBEX Serie 700 is only compatible with memory cards of a capacity greater than 16 MBytes. An hour-long episode with audio has a size of 7 MBytes.

In addition to this information, the device records the last 100 events/incidences that occurred during the different actions in the memory card, along with the corresponding ECG signal. These events/incidences are grouped according to the episode to which they belong.

Storage of the data relating to the actions will start when the device is switched on, and finishes when the device is switched off, or when the storage capacity of the memory has been exhausted. Each episode stored in the memory card is identified in an unequivocal way by means of the date and time of its onset.

All of this information can be subsequently reviewed in a PC using an application designed for such a purpose. The events/incidences can also be printed in the device's recorder using the configuration options (see Section "**11.9.2 Printing Events**").

The events/incidences that the device stores include 8 seconds prior to and/or after these episodes and a series of information common to all of the events/incidences: the lead to which the data pertains, the viewing parameters of the signal and the values of the patient's biological parameters at the time the signal was recorded.

The events/incidences that the device stores, along with the ECG signal are:

- **Defibrillation Shocks** – Each time that a defibrillation shock is delivered, this event is stored together with the value of the energy discharged.

- **Alarm Signals** - All of the alarm signals that occur during operation, indicating the alarm as well that has caused the event, and its value.
- **Start-up of the Pacemaker mode** - Each time that the pacemaker mode is accessed, the event along with the pacing parameters are stored: Rate, amplitude and pacing mode.
- **Changing the pacing parameters of the Pacemaker mode** - All of the changes in the pacing parameters that take place in the pacemaker mode are stored.
- **Inclusion of an Event** - Each time that an event is included, by using the  key on the front panel of the device, the 8 seconds prior to and after the event are recorded.
- **Pressing the Print key** – Each time the print key on the front panel is pressed, this event is stored along with the ECG signal.

These events are stored in the memory card in such a way that the last 100 recordings are always available.

To insert or to remove a memory card, the device must be switched off. If a memory card is inserted or removed when the device is switched on, loss of data can occur. Consult Section "3.5 Compact Flash Memory Card" in order to see the instructions on inserting and removing the memory card.

WARNING: Insert and remove the Compact Flash memory card only when the device is switched off. If the Compact Flash card is inserted with the device switched on, the data will not be recorded, whereas if the Compact Flash card is removed with the device switched on, the information about the current utilization will be lost.

The REANIBEX Serie 700 provides information about incidences relating to the memory card. When there is approximately 5 to 25 minutes of recording capacity that remains in the memory, the  icon will be appear in the upper part of the screen depending upon whether or not the audio recording option is active. This icon blinks when the recording capacity is almost depleted and it will change over to a fixed illuminated light when the memory capacity is filled.

The fact that the memory card is full indicates that it is not going to continue recording the continuous ECG signal and the audio (if this option is activated), however the events/incidences that occur while in operation will continue to be recorded.

If any error related to the memory card occurs while operating the device, the  icon will be displayed in the upper part of the screen. This icon will also appear when the Memory card that is inserted into the device does not have enough memory to record the events/incidences sheet (minimum 2 MB).

Blank sheet

13. Maintenance of the Device

13.1 General

Maintenance of the REANIBEX Serie 700 is essential in order to guarantee the proper operation of the device, and to detect possible anomalous conditions in it.

During the performance of the self-tests that the device conducts, if a malfunction is detected, the operation of the device depends on the type of fault detected:

- **SERVICE RECOMMENDED** – A fault is detected that affects any component of the device that is not considered to be critical to its operation or to any of the accessories. Depending upon the type of fault detected, the device can operate in some modes and not in others.

When this type of malfunction is detected, as soon as the device is switched on:

1. The LED service indicator remains switched on continuously.
2. A message will be displayed on-screen indicating the type of error detected. If it is an error that affects only one of the operating modes, whenever this mode is accessed a message will appear indicating the error detected.

- **OBLIGATORY SERVICE** – Requires the immediate intervention of authorized service personnel and it affects elements which are critical to the proper operation of the device. The device will remain out of service.

When this type of malfunction is detected, as soon as the device is switched on:

1. The LED service indicator will blink until the malfunction is corrected.
2. The screen will display the message “**ERROR XXX**” indicating the error code.

If more than 30 days have gone by since the last time a defibrillation shock or a Hardware Test was performed, when the REANIBEX Serie 700 is switched on, a warning screen will be displayed recommending to perform manual tests for the purpose of checking the integrity of the device’s different modules.

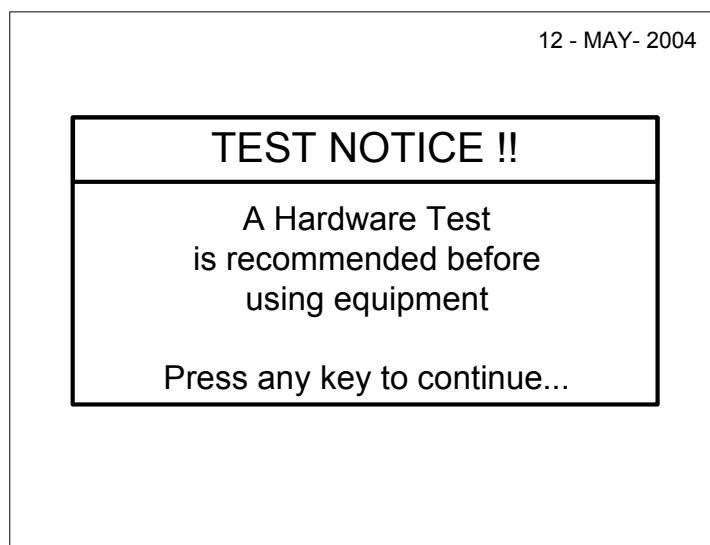

This screen appears for a few seconds, after which the device continues with its normal operation.

To prevent this screen from appearing the next time that the device is switched on, it is recommended to access the Configuration options and to perform a Hardware Test (See Section "11.7 Tests").

13.2 Routine Maintenance

In spite of the fact that the REANIBEX Serie 700 conducts self-tests at start-up and during operation in order to ensure the proper functioning of all the components of the device, this does not eliminate the need for regular maintenance of the device. Regular routine maintenance is recommended in addition to the self-tests conducted by the device.

NOTE: The result of the last 30 self-tests conducted by the device can be viewed by accessing the Configuration mode.

Follow the recommendations herein to inspect the device, the accessories and the cables:

- Make sure that the REANIBEX Serie 700 is clean every day and that both the device and its accessories do not present any visible signs of damage.

- Make sure that the connectors, patient cables and paddles are not damaged, that no cracks are evident, and that the cables are not broken. Check that the connections are secure. Check that the monitoring electrodes and defibrillation electrodes have not expired and that a sufficient quantity is available.
- Check that the battery is charged and that it does not present any signs of damage.
- Connect the device to an external power supply (AC or DC) and check that the corresponding indicator on the front panel is illuminated.
- Check that the recorder has paper and that it prints correctly.
- For those devices that have the pulse oximetry option, check that both the cable and the sensor are in perfect condition and that there are no visible signs of damage.
- The pulse oximetry module does not require any calibration by the user. The proper functioning can be checked by using a patient simulator (optional). This accessory is connected to the pulse oximetry module in place of the sensor and adjusting it to a known value verifies its performance.
- Only for devices that have the option, make sure that the memory card is inserted into the device and that it has sufficient memory capacity.
- After every utilization, ensure that all the items, accessories and replacement parts necessary for each utilization are available. Make sure the monitoring electrodes and defibrillation electrodes have not been damaged nor that they have expired.
- Conduct the manual self-tests at least once a month:
 - Switch the device on in Configuration mode
 - Access the TESTS option and run the different tests in this section, checking that the results of all of them are OK (it indicates that the self-test has been satisfactorily carried out).

13.3 Repairs and Overhauls

OSATU S.Coop. will only be liable for safety aspects of the REANIBEX Serie 700 in which the maintenance, repairs and subsequent modifications have been carried out by our technical

personnel or by companies who have our authorization and in cases where components that affect the safety of the device have been replaced by original spare parts.

The company reserves the right to carry out potential modifications without prior notice.

OSATU S.Coop will provide upon request, circuit diagrams, component lists, descriptions, calibration instructions and other information that will help suitably qualified technical personnel to repair those device components that are designated by the manufacturer as repairable.

WARNING: Dangerous electrical shock hazard. Do not open the device nor disassemble any of its components. Repair of the REANIBEX Serie 700 can only be carried out by authorized technical personnel.

13.4 Cleaning

In order to clean the REANIBEX Serie 700 device, the cables and the reusable external paddles, the following considerations must be taken into account:

- Use a slightly damp soft cloth. Do not use abrasive or inflammable cleaning products.
- Do not immerse the device in liquids.
- Clean the device with the batteries installed to prevent fluids from penetrating into the battery contacts.
- Use only the following products:
 - Isopropyl alcohol or ethyl alcohol
 - Ammonia-based cleaning products
 - Common cleaning products
 - Hydrogen peroxide
 - Soapy water

WARNING: Do not immerse the device or any part of it in water or in any other fluids. Do not use abrasive or inflammable cleaning agents.

WARNING: Do not sterilize the REANIBEX Serie 700, or its accessories, in an autoclave or with gas, unless it is specified to the contrary in the instructions for use of the accessory.

WARNING: Thoroughly clean and dry the reusable external paddles after every use. The defibrillation gel (damp or dry) accumulated in both the handles and in its receptacles can interfere in monitoring with the paddles and result in shock to the user.

If the printing quality of the recorder is not adequate, the recording head must be cleaned. For cleaning, perform the following steps:

1. Open the cover of the device where the recorder is located
2. Open the door of the recorder pressing its safety catch
3. Remove the roll of paper.
4. Clean the printing head, above the brush, with cotton moistened in isopropyl alcohol.
5. Place the new roll of paper and close the door of the recorder and the cover of the device.

13.4.1 Sterilization of the internal paddles

In this section the steam sterilization process for the internal paddles is described. Follow the instructions provided when carrying out this procedure.

WARNING: Before using the internal paddles for the first time and after each patient utilization, they must be cleaned and sterilized following the instructions as described in the User Manual.

1. Clean the surface of the electrodes and the handles with a standard hospitable solution, such as isopropyl alcohol, using a soft cloth. Do not use acetone or ammonia-based cleaners.
2. Do not put the connector into the cleaning solution.
3. Prior to sterilization, remove any excessive residue accumulated on the surface of the electrodes or on the handles.

4. In order to sterilization, coil the cables of the paddles away from handles, since they could be damaged.
5. Carry out sterilization in a gravity sterilizer using the following parameters:
 - Sterilization temperature: 121 °C
 - Sterilization time: 30 minutes
6. Protect the paddles before and after cleaning to avoid damaging their surface.

The service life of the internal paddles is affected by the number of sterilization cycles. The internal paddles supplied by OSATU have been proven to last almost for 50 steam sterilization cycles carried out with the abovementioned parameters.

13.5 Fuse replacement

The AC power input is protected from overcurrent by means of two fuses. To replace the fuses, unplug the ac power cord and open the fuse carrier door, located on the back of the equipment, with a flat-bladed screw driver. Ensure that the replacement fuses are the same type and rating as indicated on the label on the back of the equipment.

The fuses used by the REANIBEX 700 have the following characteristics: 220 VA, 3 Amp.

NOTE: Use of other fuse types may cause premature failure of the mains fuse.

13.6 Storage

When the REANIBEX Serie 700 is not being used, follow the recommendations below for storage of the device:

- Store the REANIBEX Serie 700 with the NiMH battery pack installed at temperatures between 0 °C and 40 °C.
- Store the REANIBEX Serie 700 without the NiMH battery pack installed at temperatures between 0 °C and 50 °C.

If the device is functioning outside of the recommended operating or storage temperature, the malfunction indicator located on the front panel of the device will remain switched on until the ambient temperature is within the specified range.

13.7 Battery

In this section, the considerations to be taken into account for correct battery maintenance are explained, as well as the process for changing it. Good battery maintenance optimizes its duration, and guarantees that the device provides accurate indication of the battery charge.

The REANIBEX Serie 700 uses high-capacity rechargeable NiMH batteries that require minimal maintenance. The duration of a rechargeable NiMH battery depends on its frequency and use. When used and maintained correctly the service life of the battery is 5 years or 500 charge/shock cycles.

Adequate maintenance of the battery implies taking the following considerations into account:

- Store the battery at temperatures less than 30 °C and never expose the battery to high temperatures, greater than 40 °C.
- Carry out complete battery discharges periodically (once a month is recommended) therefore switch on the device without connecting it to any external power supply until the battery status indicator lights up in red.
- If the battery of the device is left out for a long period of time and is stored at a temperature less than 30 °C, recharge the battery every 6 months.

WARNING: Use only batteries supplied by OSATU or by its authorized distributors. The use of another type of battery can cause device malfunction.

WARNING: Storage of the batteries at temperatures greater than 30 °C significantly reduces their lifespan.

When the device performs self-tests at start-up and during operation, it checks the battery charge giving the appropriate instructions in case its charge is low.

If the battery indicator located on the front panel of the device is red at start-up, it indicates that the battery need to be charged by connecting the device to an external power supply (car battery or AC mains).

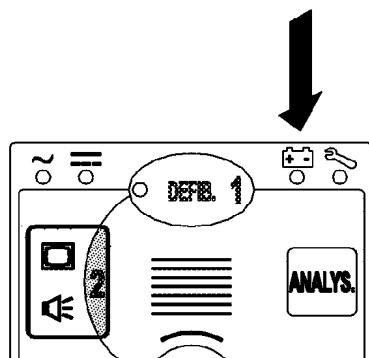

WARNING: Explosion hazard. Do not recharge the REANIBEX Serie 700 batteries outside of the device since they could explode.

Store the new battery packs at temperatures between 0 °C and 35 °C. The optimal temperature for storage of the batteries is 25 °C.

When the battery is stored under optimal conditions, its capacity is equivalent to more than 130 shocks of 200 J, or more than 150 minutes of monitoring, or more than 120 minutes of monitoring plus pacemaker pacing at 60 mA and 60 bpm.

Changing the external battery of the device is shown in the following drawing:

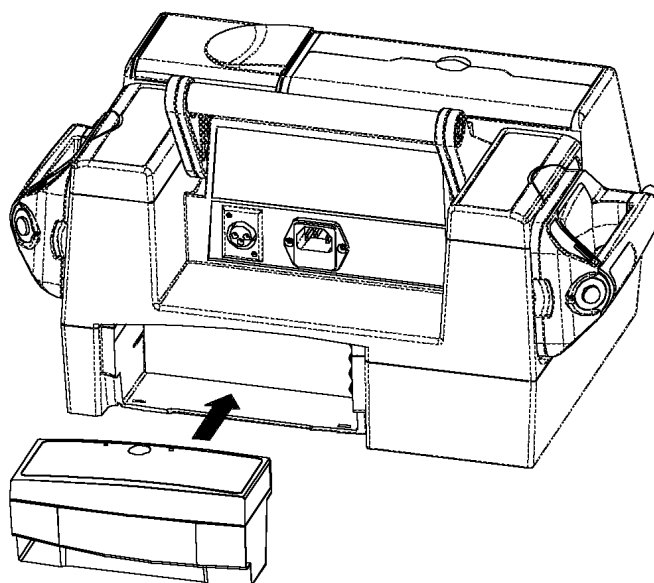

When the battery is installed in the equipment, and this in turn is connected to an external power supply (AC mains or car battery), the device continuously charges the battery, using an internal charger.

To remove the battery, pull the device's battery lock latch (black-coloured) upwards and holding it in this position, remove the battery from its compartment.

If there is visible damage or if they become damaged, the NiMH batteries must be recycled. Siga las indicaciones locales, regionales o nacionales de su país a la hora del reciclaje.

WARNING: Follow the local, regional or national instructions of your country to recycle the REANIBEX Serie 700 batteries or send them to OSATU S. Coop.

WARNING: Explosion hazard. Do not try to open or handle the battery. Do not incinerate the battery. Avoid electrical contact between the battery terminals.

13.8 Recycling

- The REANIBEX Serie 700 must be cleaned and disinfected before being recycled. The device must be recycled according to the recommendations of the local, regional or national authorities of each country.
- Once their service life is over, the NiMH batteries must be recycled according to the local, regional or national procedures of each country.
- The single-use defibrillation electrodes must be recycled in accordance with local, regional or national clinical procedures of each country.
- The device packaging must be been recycled in accordance with the local, regional or national regulations of each country.

WARNING: Follow the local, regional or national instructions of your country to recycle the REANIBEX Serie 700 batteries or send them to OSATU S. Coop.

13.9 Check list

The recommended checks and tests to perform to ensure the proper operation of the device is listed below.

Serial Number:	Date:
Operative:	Signature:



Operation/Incident	Recommended Action	Result
1. Visual inspection of the device <ul style="list-style-type: none"> • The device is dirty • There are cracks or damage 	<ul style="list-style-type: none"> • Clean the device • Contact the Technical Service 	
2. Visual inspection of the accessories <ul style="list-style-type: none"> • Connectors, cables or paddles are damaged or broken • Battery is damaged or leaking • Discharged battery • Inspection of the recorder paper 	<ul style="list-style-type: none"> • Contact the Technical Service • Replace the battery • Charge the battery • If there is no paper, replace the recorder paper 	
3. Expiry dates <ul style="list-style-type: none"> • Monitoring or defibrillation electrodes expired • Monitoring or defibrillation electrodes open 	<ul style="list-style-type: none"> • Replace the expired electrodes • Replace the open electrodes 	
4. Power Supply <ul style="list-style-type: none"> • Connect the device to an external V AC source and check the indicator • Connect the device to an external V DC source and check the indicator 	<ul style="list-style-type: none"> • If the indicator does not light up, contact the Technical Service • If the indicator does not light up, contact the Technical Service 	
5. Integrity of the device <ul style="list-style-type: none"> • Run the Hardware Test • Run the Accessories Test • Run the Front Panel Test • Run the Paddle Interface Test 	<ul style="list-style-type: none"> • If there is any error, contact the Technical Service • If there is any error, contact the Technical Service • If there is any error, contact the Technical Service • If there is any error, contact the Technical Service 	

14. Troubleshooting

The REANIBEX Serie 700 has different methods to indicate that an error or problem has been detected during the execution of the self-tests that the device performs at start-up, during operation or due to actions by the user.

Depending upon the severity of the problem, the indicators can be luminous, on-screen, audible voice prompt messages or beeps.

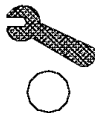
The following table lists the main problems that can occur in the device, the indication that the device provides, their possible cause, and the required action to take in order to resolve them.

ERROR/ INDICATOR	POSSIBLE CAUSE	ACTION TO TAKE
GENERAL		
The REANIBEX Serie 700 does not switch on	<ul style="list-style-type: none"> The device has no power supply Internal fuse blown 	<ul style="list-style-type: none"> Replace the battery with a new one or connect the device to an external power supply Contact the Authorized Technical Service Personnel
MALFUNCTION INDICATOR BLINKING 	<ul style="list-style-type: none"> OBLIGATORY SERVICE ERROR. An error is detected in one of the critical components of the device. 	<ul style="list-style-type: none"> Contact the Authorized Technical Service Personnel
MALFUNCTION INDICATOR FIXED 	<ul style="list-style-type: none"> RECOMMENDED SERVICE ERROR. An error has been detected in some of the components of the device which are not considered critical. The device can continue operating in some modes The device is operating outside of operating temperature range 	<ul style="list-style-type: none"> Enter into Configuration Mode and perform a Hardware Test and an Accessories Test. If the result of these Tests is satisfactory the device can continue to be used. If an error persists, contact the Technical Service personnel Try to work with the device in an environment with temperatures within the stated operating range

BATTERY INDICATOR FIXED

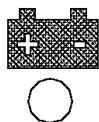

- The device's battery level is LOW
- Replace the battery with one that is fully charged as soon as possible
- Connect the device to an external power supply

The I/O key is pressed but no message appears on the screen of the device

- The battery is completely exhausted.
- The REANIBEX Serie 700 needs repair.
- Replace the battery with a fully charged one or connect the device to an external power supply.
- Contact the Authorized Technical Service Personnel

The device operates but the screen does not light up or is not clearly seen

- The screen contrast is not properly adjusted
- The screen is not working properly
- Adjust the screen contrast up to a suitable level
- Contact the Authorized Technical Service Personnel

When the device is switched on the following icon appears



- There is no Compact Flash card inserted in the device
- There is an error in the Compact Flash card
- Insert a card with sufficient memory capacity
- Replace the Compact Flash card with a new one

When the device is switched on the following icon appears



- The capacity of the Compact Flash memory has been exhausted
- Insert a new card with sufficient memory capacity

One or several of the device keys do not respond

- Possible defect in the device keyboard
- Run the User Interface Test to check if all the keystrokes are detected, and if not, send it to the Technical Service
- The device is in an operating mode that does not correspond with the pressed key
- Make sure that the pressed key pertains to the selected operating mode.

The VT/VF alarm cannot be selected on the alarms screen

- There is an error in the Semi-Automatic Defibrillator operating mode
- Access configuration and run a Hardware Test to check the operation of the different modules. If any error is detected contact the Technical Service personnel.

MONITOR MODE

An audible indicator is not heard for every QRS

- The QRS beep is deactivated
- The QRS amplitude is too small
- Activate the QRS beep (the icon will not appear on-screen)
- Change the lead that is being used for the HR

The quality of the signal from the monitoring electrodes is poor

- There is a bad contact between the monitoring electrodes and the patient
- The monitoring electrodes are dried out or have expired
- There is RF interference that distorts the signal
- The patient cable could be defective
- The electrical installation connected to the equipment does not have a ground connection
- Check that the monitoring electrodes have been correctly positioned and if necessary prep the patient's skin and re-position them.
- Check the expiry date of the electrodes. Do not open the electrodes packet until the time it is used
- Monitor the patient as far away as possible from the device that can cause interference.
- If another patient cable is available, replace it and if not, send the cable to the Technical Service
- If this ground connection is not available, connect the equipotential conductor located in the back panel of the device to any metal element accessible in the building structure.

<p>The quality of the signal from the defibrillation electrodes or paddles is poor</p>	<ul style="list-style-type: none"> • There is a bad contact between the defibrillation electrodes or paddles and the patient • The defibrillation electrodes are dried out or have expired • There is RF interference that distorts the signal • The patient cable could be defective • The electrical installation connected to the equipment does not have a ground connection 	<ul style="list-style-type: none"> • Check that the defibrillation electrodes have been properly positioned and that the patient's skin has been correctly prepped • Check the expiry date of the electrodes. Do not open the electrodes packet until the time it is used • Monitor the patient as far away as possible from the device that can cause interference. • If other defibrillation electrodes or paddles are available, replace them • If this ground connection is not available, connect the equipotential conductor located in the back panel of the device to any metal element accessible in the building structure.
<p>When a patient cable lead is selected, a broken line is displayed and the following icon appears</p>	<ul style="list-style-type: none"> • There is a disconnected patient cable lead • Contact between the cable leads and the patient is not adequate 	<ul style="list-style-type: none"> • Check all the patient cable leads and if there is any disconnected lead, connect it. • Check that the monitoring electrodes have been correctly positioned and if necessary prep the patient's skin and re-position them.
	<p>The lead selection key does not respond, or only the PADDLES option is displayed</p>	<ul style="list-style-type: none"> • The patient cable is not properly connected. • The device is operating in Semi-Automatic Defibrillator mode with only single-use multifunction electrodes
<p>Neither the SpO2 value nor waveform is shown</p>	<ul style="list-style-type: none"> • The sensor is not properly connected or the cable is damaged 	<ul style="list-style-type: none"> • Check that the patient cable is properly connected. • None • Check the connection of the sensor and the cable or position it properly • Test it using another sensor

The following icon appears on the screen



- The sensor is disconnected from the cable
- The device does not detect that the sensor is connected
- Excessive ambient lighting
- Check that the sensor is properly connected
- Check that the sensor has been positioned in the proper area
Change the sensor or its position
- Remove or block the light source or cover the sensor with a non transparent material

The following icon appears on the screen



- There is an error in the pulse oximetry module
- Contact the Technical Service

MANUAL DEFIBRILLATOR MODE

On-screen message “**NO SHOCK DELIVERED**”

- The shock button was not pressed within 60 seconds after charging
- The energy selection was changed after charging
- The synchronization option was deactivated before charging
- Deliver the shock to the patient in less than 60 seconds
- None
- Maintain synchronization until the shock is delivered

On-screen message “**PRESS ELECTRODES**” or “**PRESS PADDLES**”

- There is not a proper connection between the single-use multifunction electrodes or the paddles and the patient
- Connect the single-use multifunction electrodes properly or press the paddles.

On-screen message “**PRESS CHARGE**”

- The shock button was pressed without first charging the energy
- Prior to delivering the shock, press the CHARGE key in order to deliver the shock

On-screen message “**SEARCHING QRS**” and does not deliver the energy shock

- The synchronization option is activated and cannot find any QRS complex
- Change the lead that is being used to detect QRS complexes in order to better detect these complexes

On-screen displays the message “**NO QRS DETECTED**”

- 4 seconds have passed since the shock button was pressed without any QRS being detected
- Change the lead in order to better detect the QRS complexes

<p>The shock was not delivered when the paddle shock buttons were pressed</p>	<ul style="list-style-type: none"> • The reusable external paddles are defective 	<ul style="list-style-type: none"> • If possible, deliver the shock using the single-use multifunction electrodes. • Send the paddles to the Technical Service
---	---	--

<p>On-screen message “DEFIBRILLATOR MODE ERROR”</p>	<ul style="list-style-type: none"> • An error has been detected in the defibrillation module 	<ul style="list-style-type: none"> • Contact the Technical Service Personnel
---	---	---

SEMI-AUTOMATIC DEFIBRILLATOR MODE

<p>Audible and on-screen message "PRESS ELECTRODES" or "CONNECT ELECTRODES"</p>	<ul style="list-style-type: none"> • Electrodes are not connected to the patient properly. • Defective, expired or dried out electrodes. • Defective electrodes connector. • Reusable external paddles are connected 	<ul style="list-style-type: none"> • Press the electrodes on the patient • Re-position the electrodes • Clean, wash and dry the patient’s skin. • Check the device connector. • Use single-use multifunction electrodes for operating in Semi-Automatic Defibrillator mode.
---	--	--

<p>Audible and on-screen message “NO SHOCK DELIVERED”</p>	<ul style="list-style-type: none"> • The REANIBEX SERIE 700 has detected a shockable rhythm, but the shock button has not been pressed within the 15 seconds after charging the capacitor, and the device has internally discharged 	<ul style="list-style-type: none"> • When the next “SHOCK ADVISED” indication (on-screen and audible) is given, press the SHOCK within the next 15 seconds.
---	--	--

<p>The  key is pressed, but the analysis does not start</p>	<ul style="list-style-type: none"> • Reusable external paddles are connected • The device is carrying out the analysis • Failure in the keys on the front panel 	<ul style="list-style-type: none"> • Connect the single-use multifunction electrodes • Do not press the key during the analysis of the signal • Check the keys using the User Interface Test
--	--	---

PACEMAKER MODE

<p>On-screen message “CONNECT ELECTRODES”</p>	<ul style="list-style-type: none"> • The single-use multifunction electrodes are not connected to the patient 	<ul style="list-style-type: none"> • Correctly connect the electrodes to the patient
---	--	---

<p>On-screen message "SELECT PACEMAKER AMPLITUDE"</p>	<ul style="list-style-type: none"> • The pacing current of the pacemaker is set at 0 mA and pacing is not taking place 	<ul style="list-style-type: none"> • Fix a pacing current value other than 0 mA
---	---	--

<p>On-screen message "PACEMAKER ERROR"</p>	<ul style="list-style-type: none"> • A failure has occurred in the pacemaker module. The device cannot be used 	<ul style="list-style-type: none"> • Contact the Authorized Technical Service Personnel
---	---	--

RECORDER

<p>The following icon appears on-screen</p> <div style="text-align: center; margin: 10px 0;">  </div>	<ul style="list-style-type: none"> • The door of the recorder is open • The recorder has no paper • There is an error exists in the recorder 	<ul style="list-style-type: none"> • Close the door of the recorder properly • Replace the roll of paper in the recorder with a new one • Contact the Authorized Technical Service Personnel
--	---	---

<p>The paper doesn't move or becomes jammed</p>	<ul style="list-style-type: none"> • The roll of paper has been incorrectly loaded or has become jammed • The paper is damp • The door of the recorder is not closed correctly 	<ul style="list-style-type: none"> • Change the roll of paper once again or unblock it • Replace the roll of paper • Close the door of the recorder properly
---	---	---

<p>Nothing is printed or the printing is scarcely visible</p>	<ul style="list-style-type: none"> • The roll of paper has been incorrectly loaded • The type of paper introduced is not correct • The temperature of the thermal head is near the recommended maximum 	<ul style="list-style-type: none"> • Change the roll of paper once again or unblock it • Change the roll of paper for one of the recommended types • Wait until the recording head cools
---	---	---

<p>Printing quality is bad or blank areas appear</p>	<ul style="list-style-type: none"> • The printing head is dirty 	<ul style="list-style-type: none"> • Clean the printing head
--	--	---

<p>Squeaking is heard during printing</p>	<ul style="list-style-type: none"> • Correctly close the door of the recorder 	<ul style="list-style-type: none"> • Close the door of the recorder properly
---	--	---

Blank sheet

A.1 Symbols of the REANIBEX Serie 700

SYMBOL	MEANING
	General ON/OFF button of the device.
	BATTERY STATUS indicator
	MALFUNCTION indicator
	Indicates that the device is connected to an external ALTERNATING POWER SUPPLY source (V AC)
	Indicates that the device is connected to an external DIRECT POWER SUPPLY source (V DC)
	RECORD key to activate/deactivate the RECORDER
	Automatic RECORD key for all LEADS
	EVENTS key
	MENU key
	FUNCTION keys
	SUSPENDED SOUND ALARM key.
	On-screen signal FREEZE key
	CHARGE key for the selected energy level

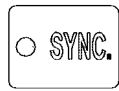

Synchronization ACTIVATION/DEACTIVATION key



ENERGY SELECTION keys



ECG signal ANALYSIS start key



SHOCK button

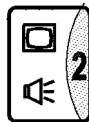

Icon for following the audible and visual INSTRUCTIONS of the device when it is operating in Semi-Automatic Defibrillator mode.



Pacemaker pacing CURRENT SELECTION keys



Pacemaker pacing RATE SELECTION keys

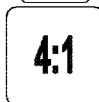

Key for reducing the pacing rate by 4 (while it is being pressed)



Microphone (Only for device with this option)



Equipotential Conductor



**10-16V
10 A**

Connection for the direct external power supply (car battery)



**100-240 V
50-60 Hz
220 VA
2xT, 3Amp**

Connection for the alternating external power supply (AC mains)



Not defibrillation-protected CF type device



**Defibrillation-protected.
CF type device**













WARNING: See accompanying documents

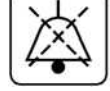

**Certification symbol in accordance with the
Directives for Medical Devices 93/42/CEE**

A.2 Screen Symbols

SYMBOL	MEANING
XX:XX:XX	TIME ELAPSED since the device was switched on or real time (depends upon the configuration)
 140	HEART RATE
 140	LOW CONFIDENCE in the PULSE RATE obtained from the pulsioximeter
 - - -	HEART RATE cannot be obtained
	PATIENT CABLE LEAD disconnected
	RECORDING ERROR (includes the lack of paper and the door being open)
	QRS BEEP DEACTIVATED
	ALARM SOUND SUSPENDED
	COMPACT FLASH FULL
	COMPACT FLASH ERROR or no card installed
	VT/VF ALARM ACTIVATED and analyzing ECG signal
 1	NUMBER of SHOCKS delivered in Semi-Automatic Defibrillator mode



BATTERY STATUS CHARGE

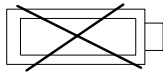

There is NO BATTERY INSTALLED in the device



SpO2%, signal intensity and perfusion index

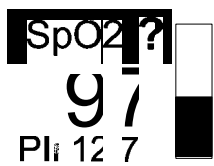

LOW CONFIDENCE in shown SpO2 % value

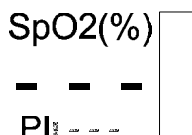

SpO2% and PI can not be obtained



SpO2 SENSOR NOT CONNECTED to the device or is connected to the device but not to the patient



PULSE OXIMETRY ERROR module

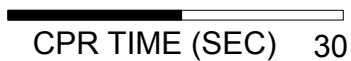







TIME REMAINING for CPR



CHARGING CAPACITOR to the selected energy level

A.3 Battery Symbols

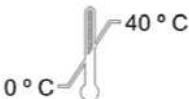
SYMBOL	MEANING
	WARNING: See accompanying documents
	Recyclable material. Heavy metal substances. Must be disposed of properly
	Do not try to open the battery casing
	Do not expose the battery to excessive heat or to flames. Do not incinerate the battery
LOT	Manufacturing batch of the battery
	Date of manufacturing of the battery
	Electrical and electronic equipment in accordance with Article 11(2) of Directive 2002/96/CE on electronic and electrical equipment residue
	Rechargeable Battery
	Battery operating temperature range

A4. List of Events

ABBREVIATION	NAME	ABBREVIATION	NAME
ADRE	Adrenaline	CPR	Cardio Pulmonary Resuscitation
ATROP	Atropine	MAG	Magnesium
AMIOD	Amiodarone	MORPH	Morphine
VASOP	Vasopressin	ADENO	Adenosine
OXYG	Oxygen	DIGOXIN	Digoxin
BICARB	Bicarbonate	OTI	Oral Tracheal Intubation
LIDO	Lidocaine	VERAP	Verapamil
PROCA	Procainamide	B-BLOC	Beta-Blocker
SEDAT	Sedation	NITRO	Nitroglycerine
MIDAZ	Midazolam	HEP	Heparin
MUS. REL.	Muscle Relaxer	CAR. MASS.	Cardiac Massage
DOPA	Dopamine	ASA	Aspirin
DOBUT	Dobutamine	VALIUM	Valium
ISOPRO	Isoprotenerol	EPI	Epinephrine

A.5 On-screen and/or audible messages

MESSAGE	DESCRIPTION	AUDIO
CONNECT ELECTRODES	Detects when the electrodes are not connected to the patient	Yes
PRESS ELECTRODES ON THE PATIENT	Detects when the electrodes are not correctly connected to the patient	Yes
CHECK ELECTRODES	Detects short circuit in the electrodes	No
CHECK PADDLES	Detects short circuit in the paddles	No
PRESS PADDLES	The reusable paddles are not connected to the patient	No
SELECT DEFIBRILLATOR MODE	A Defibrillator Mode key is pressed when working in another mode	No
PRESS CHARGE	The shock button has been pressed without first charging the energy	No
ENERGY XXX J	The energy that has been selected in Manual Defibrillator mode	No
XXX J DISCHARGED	The energy that has been delivered to the patient	No
CHARGING	The energy is being charged	No
CHARGE ABORTED	During energy charging, one of the increase/decrease energy keys is pressed	No
SEARCHING FOR QRS	Waiting to detect a QRS before delivering the shock	No
NO QRS DETECTED	No QRS is detected in less than 4 seconds	No
DISCONNECT PADDLES	The ANALYS key is pressed when reusable paddles are connected	No
DEFIBRILLATOR: ERROR XXX	An error is detected in the defibrillation module. The error code detected is indicated	No
EXAMINE PATIENT	The VT/VF alarm signal goes off	No
DISARM VT/VF ALARM	The automatic record key for all the leads is pressed when the VT/VF alarm is active	No

SELECT AMPLITUDE	The Pacemaker pacing current selected is 0 mA	No
PACEMAKER: ERROR XXX	An error is detected in the pacemaker module. The error code detected is indicated	No
ANALYSING NOW. STAND CLEAR	The patient's ECG signal is being analyzed. Do not touch the patient.	Yes
SHOCK ADVISED	A shockable rhythm is detected after analyzing the patient's ECG	Yes
NO SHOCK ADVISED	A rhythm that cannot be defibrillated is detected after analyzing the patient's ECG	Yes
IF NO SIGNS OF CARDIAC ACTIVITY, START CPR	After a rhythm that cannot be defibrillated has been detected, if the patient has no pulse, CPR must be initiated	Yes
CPR TIME (SEC)	Time remaining to carry out CPR before the device analyzes the ECG signal once again	Yes
STAND CLEAR	Analysis of the ECG signal is going to start and everyone must stand clear of the patient	Yes
PUSH TO SHOCK	The device indicates that the SHOCK button must be pressed to administer treatment to the patient.	Yes
NO SHOCK DELIVERED	An internal discharge has taken place	Yes
ASYSTOLE	The device detects that the patient is in asystole.	Yes
PRESS ANALYSIS TO START	The CPR time has been configured as OFF. The ANALYS. Key must be pressed to initiate a new analysis	Yes

A.6 Device Events



EVENT	DESCRIPTION
START-UP	The device has been switched on
MANUAL DEF. MODE	Access to the Manual Defibrillator mode
AUTO. DEF. MODE	Access to the Automatic Defibrillator mode
MONITOR MODE	Access to Monitor mode
PACEMAKER MODE	Access to the Pacemaker mode
P.C. CONNECTED	Patient cable connected
P.C. DISCONNECTED	Patient cable disconnected
ELECTRODES CONNECTED	Single-use multifunction electrodes connected
ELECTRODES DISCONNECTED	Single-use multifunction electrodes disconnected
INT. PADDLES CONNECTED	Internal paddles connected
INT. PADDLES DISCONNECTED	Internal paddles disconnected
PRESS ELECTRODES	The single-use multifunction electrodes are not connected correctly
EVENT	Event entered (indicates the type of event)
LEAD	Indicates the lead being viewed
SENSITIVITY	Indicates the selected sensitivity
FILTER (YES/NO)	Activation/Deactivation of the filter
ALARMS ON-OFF	Activates or deactivates the alarm sound
VT/VF Alarm: YES	The VT/VF alarm is activated (only for devices with this option)
MAX HR CONF	New limit for the maximum Heart Rate
MIN HR CONF	New limit for the minimum Heart Rate
MAX SpO2 CONF	New limit for the maximum SpO2 %
MIN SpO2 CONF	New limit for the minimum SpO2%

VT/VF ALARM	The VT/VF alarm is signaled (only for devices with this option)
HR > MAX	Triggers the maximum Heart Rate alarm
HR < MIN	Triggers the minimum Heart Rate alarm
SpO2 > MAX.	Triggers the maximum SpO2% alarm
SpO2 < MIN.	Triggers the minimum SpO2% alarm
ANALYSIS	Number of analyses carried out from the start of the utilization
SHOCK ADVISED	Detects a shockable rhythm in Semi-Automatic Defibrillator mode
NO SHOCK ADVISED	Detects a rhythm that cannot be defibrillated in Semi-Automatic mode
CHARGE	Indicates that the capacitor has been charged to the selected energy level
SHOCK	Shock delivered and value of the energy in Joules
NO SHOCK DELIVERED	An internal discharge has taken place
PACEMAKER MODE	Indicates the Pacemaker pacing mode
PACEMAKER AMP.	A new Pacemaker amplitude is set
PACEMAKER RATE	A new Pacemaker rate is set
(4:1) PAUSE	The 4:1 key of the Pacemaker mode is pressed
SYNC. ON-OFF	Activates/Deactivates the synchronized shock option
ASYSTOLE	Asystole Detection
START CPR	Beginning of CPR time
NO ANALYSIS	The ECG signal cannot be analysed
SWITCHED OFF	The device has been disconnected

Blank sheet

A.7 Device Labels

In the upper part of the device, there is a label that contains a series of warnings and precautions that must be followed when using the device, and the basic instructions for use of the device:

WARNINGS	INSTRUCTIONS
<p>DANGER:</p> <ul style="list-style-type: none"> • Risk of explosion. Do not use in presence of inflammable gases. <p>CAUTION:</p> <ul style="list-style-type: none"> • Dangerous electric current. Only for use by competent personnel. • Do not open, risk of electric shock. In the event of a breakdown, contact qualified personnel. 	<p>MANUAL DEFIBRILLATION:</p> <ol style="list-style-type: none"> 1 — Select defibrillator mode. 2 — Select Energy and press CHARGE. 3 — Press  to apply energy.

In the lower part of the device, the following label appears, where the serial number of the device is indicated.



In the upper part of the device, just below the protection cover of the Compact Flash and only for those devices which have the Automatic Defibrillation option, the following label appears to

remind the user to switch off the device before inserting and removing the Compact Flash memory card:

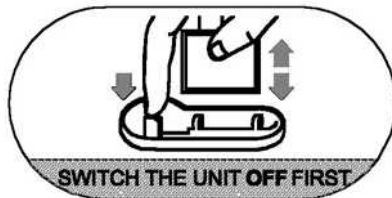

A.8 Battery Label

The label included in the battery holds information relating to the features of the battery (type, capacity, voltage, batch and date of manufacturing), as well as recommendations on handling and storage.

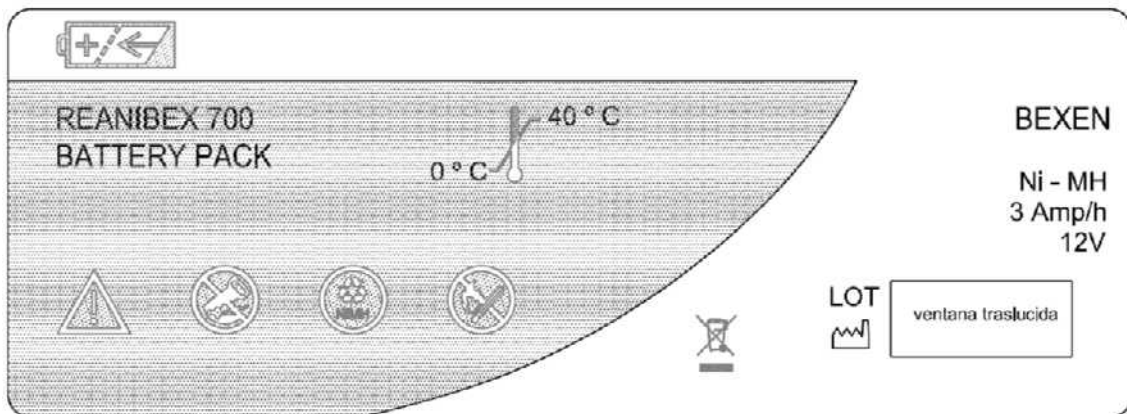

Blank sheet

A.9 Technical Specifications

TECHNICAL SPECIFICATIONS	
Electrical Protection	Input protected against high voltage defibrillation pulses (IEC 60601)
Safety Classification	IEC 60601, CF type. Class I, internally powered Continuous operating mode
MONITOR	
ECG	Monitored by means of 4, 5 and 10 lead cable, reusable internal or external paddles and single-use multifunction electrodes
Leads	<ul style="list-style-type: none"> - 4 Lead cable: PADDLES, I, II, III, aVR, aVL and aVF - 5 Lead cable: PADDLES, I, II, III aVR, aVL, aVF and V - 10 Lead cable: PADDLES, I, II, III, aVR, aVL, aVF and V1 to V6
Lead-Off Indicator	<p>An on-screen icon appears when any lead is off or poorly connected</p> <p>The amplitude of the current applied to the patient to detect a lead-off is less than 0.5 uA.</p>
Size of the ECG	0.5, 1, 2 and 4 cm/mV selectable from the front panel
ECG on-screen speed	25 mm/sec
Frequency response	<ul style="list-style-type: none"> - AC Filter (50/60 Hz). - Diagnostic: 0.05-150 Hz (only in recorder) - Muscle artifact filter: 0.67-40 Hz (only in recorder) - Screen response: 0.05-25 Hz
Heart Rate	30-300 bpm \pm 10 % displayed on the device screen
Accuracy in the heart rate and response to an arrhythmia	Conforms to Safety Standard IEC 60601-2-27:2005 for ventricular bigeminy (HR=40 bpm)
Averaged heart rate	<ul style="list-style-type: none"> - For heart rates greater than or equal to 50 bpm, the 8 most recent R-R intervals are used for averaging

	<p>the heart rate</p> <ul style="list-style-type: none"> - For heart rates lower than 50 bpm, the 4 most recent R-R intervals are used for averaging the heart rate
Heart rate response time	<ul style="list-style-type: none"> - From 80 to 40 bpm: 3 seconds - From 80 to 120 bpm: 2 seconds
Alarm response time for tachycardia	<ul style="list-style-type: none"> - 206 bpm (1 mV): 2 seconds - 206 bpm (half amplitude): 3 seconds - 206 bpm (double amplitude): 3 seconds - 195 bpm (2 mV): 2 seconds - 195 bpm (half amplitude): 2 seconds - 195 bpm (double amplitude): 2 seconds
Capacity to reject T-waves	Rejects T-waves with a maximum amplitude of 0.7 mV
Alarms	<ul style="list-style-type: none"> - Maximum and Minimum Heart Rate - Maximum and Minimum SpO2% (only with pulse oximeter option) - VT/VF Alarm (only with the Semi-Automatic Defibrillator option)
Common mode rejection	> 100 dBs
Simultaneous use of the REANIBEX Serie 700 with other equipment connected to the patient	<ul style="list-style-type: none"> - The REANIBEX Serie 700 can be utilized simultaneously with an electrosurgical unit. A defect in the neutral electrode of the electrosurgical unit does not represent any safety risk for the patient since the device provides protection against high-frequency burns. This protection resides in the fact that the patient cable is electrically isolated through a ground connection. Consult the Instructions for Use for the electrosurgical unit to reduce the risk of burns in case of a defect in this device. - The simultaneous use of the REANIBEX Serie 700 with an external pacemaker and other electrical pacers connected to the patient do not represent any safety risk. The device could detect the internal pacemaker pulses as QRS complexes which results in an indication of an incorrect heart rate.

SpO2 Pulse Oximetry (Optional)		
Saturation (% SpO₂) range	1-100%	
Saturation (%SpO₂) accuracy during no motion conditions	Adults/Peditrics	70% - 100 % : ± 2 digits
		0% - 69 % : Not especificied
	Neonates	70% - 100 % : ± 3 digits
		0% - 69 % : Not especificied
Saturation (%SpO₂) accuracy during motion conditions	Adults/Peditrics /	70% - 100 % : ± 3 digits
	Neonates	0% - 69 % : Not especificied
Saturación (% SpO₂) resolution	1%	
Pulse Rate Range (bpm)	25-240 bpm	
Pulse rate (ppm) accuracy during no motion conditions	± 2 bpm	
Pulse rate (ppm) accuracy during motion conditions	± 5 bpm	
Pulse rate (ppm) resolution	1 bpm	
DEFIBRILLATOR		
Waveform	Biphasic truncated exponential, with energy compensation according to the patient's impedance	
Output Energy Accuracy (over 50 Ω)	± 15 % or ± 3 J, whichever is greatest in the entire range	
Manual Defibrillator		
Output energy		
External paddles	1 - 2 - 3 - 5 - 7 - 9 - 10 - 15 - 20 - 30 - 50 - 70 - 100 - 125 - 150 - 200 Joules.	
Internal paddles	1 - 2 - 3 - 5 - 7 - 9 - 10 - 15 - 20 - 30 - 50 Joules	
Paddles Options	- Reusable external paddles	

	<ul style="list-style-type: none"> - Internal paddles - Multifunction single-use cable-electrodes - Permanent single-use multifunction electrode cable
Energy Selection	Front panel button and external paddle buttons
Charge Control	Front panel button and external paddle buttons
Charge Indicator	Charging tone, end of charge tone, LED in charge button and shock button on the front panel blinking for single-use multifunction electrodes and internal paddles
Shock Control	Buttons on the external paddles, front panel button for single-use multifunction electrodes and internal paddles
Charging time	<ul style="list-style-type: none"> - Less than 5 seconds at 200 J with a new and fully charged NiMH battery pack at 25°C. - Less than 10 seconds without a battery pack and connected to a power voltage at 90-100 % of the nominal value. - Less than 10 seconds with a new and fully charged NiMH battery pack, depleted with 15 shocks at 200 J at 25°C.
Maximum time from the initial power supply connection until ready to shock status	<ul style="list-style-type: none"> - Less than 10 seconds from initial start-up with a new and fully charged NiMH battery pack. - Less than 15 seconds from initial start-up, without a battery pack, and connected to a power voltage at 90-100 % of the nominal value. - Less than 15 seconds with a new and fully charged NiMH battery pack, depleted with 15 shocks at 200 J at 25°C.
Synchronization	Front panel button. On-screen indication of the synchronization points
Maximum time delay between the synchronization pulse and energy delivery	Energy delivery is carried out within 60 ms following the detection of a QRS peak

Semi-Automatic Defibrillation (Optional)	
Output energy	Maximum: 200 J ± 15 %
Paddle Options	<ul style="list-style-type: none"> - Single-use multifunction cable-electrodes - Permanent cable with single-use electrodes
Guide messages	Emission of on-screen and audible voice prompt messages that guide the user during operations
Charge Indicator	Charging tone, end of charge tone and blinking front panel shock button
Shock Control	Front panel button
Configuration of utilization parameters	By means of the corresponding Configuration Mode options
Detection features	<ul style="list-style-type: none"> - VF Sensitivity: Conforms to AHA Safety Standards - VT Sensitivity: Conforms to AHA Safety Standards - NSR Specificity: Conforms to AHA Safety Standards - Specificity of other signals: Conforms to AHA Safety Standards
Maximum time from the start of the rhythm analysis until ready to shock status	<ul style="list-style-type: none"> - Less than 20 seconds with a new and fully charged NiMH battery pack. - Less than 20 seconds without a battery pack and connected to a power voltage at 90-100 % of the nominal value. - Less than 20 seconds with a new and fully charged NiMH battery pack, depleted with 15 shocks at 200 J at 25°C.
Maximum time from the initial power supply connection until ready to shock status	<ul style="list-style-type: none"> - Less than 26 seconds with a new and fully charged NiMH battery pack. - Less than 26 seconds without a battery pack and connected to a power voltage at 90-100 % of the nominal value. - Less than 26 seconds with a new and fully charged NiMH battery pack, depleted with 15 shocks at 200 J at 25°C.
PACEMAKER (Optional)	

Waveform	Rectilinear continuous current
Pulse width	40 msec
Amplitude	From 0 to 150 mA in increments of 5 mA
Rate	From 30 to 180 bpm in increments of 5 bpm
Operating modes	<ul style="list-style-type: none"> - Fixed - On-Demand
Refractory period	<ul style="list-style-type: none"> - 240 msec from 30 to 80 bpm - 340 msec from 85 to 180 bpm
SCREEN	
Size	<ul style="list-style-type: none"> - 120 x 89 mm (SP14Q001 - Hitachi) - 115.2 x 86.4 mm (EL320.240.36 HB -Planar)
Type	<ul style="list-style-type: none"> - LCD with backlight (SP14Q001- Hitachi) - High Resolution EL (EL320.240.36 HB–Planar)
Resolution	320 x 240 pixels (1/4 VGA)
Sweep rate	25 mm/sec
Waveform viewing time	4.5 seconds
Recorder (Optional)	
Continuous ECG strip	<p>Prints a continuous strip with one ECG channel along with the annotations and events.</p> <p>For devices with pulse oximetry option, 2 channels can be printed: The ECG signal and the pleth waveform (SpO2)</p>
Automatic Printing	It can be configured to automatically print the 8 seconds prior to and after the events that set off alarms and defibrillation shock events.

Reports	<ul style="list-style-type: none"> - Utilization performance report - Heart Rate Trends and SpO2% graphs (optional) - Results of the manual tests and the device self-tests. - Configuration parameters - Events/incidences stored in the memory card along with the corresponding ECG signal.
Paper Width	50 mm
Speed	10, 25 and 50 mm/sec \pm 5 %
DATA STORAGE (Optional)	
Memory Type	External removable Compact Flash memory card
Capacity	Minimum 16 MB, equivalent to 4 hours of continuous ECG signals plus audio
Data	<ul style="list-style-type: none"> - Continuous ECG plus audio (optional) - Significant incidences/events along with the corresponding ECG
GENERAL	
Indicators	<ul style="list-style-type: none"> - Battery Status Indicator - Device malfunction indicator - Power supply indicator - Charge indicator - Energy charged indicator - Synchronization indicator
Self-tests	<ul style="list-style-type: none"> - At start-up - While operating - Manuals on request by user
POWER SUPPLY	
Battery	

Type	NiMH (rechargeable)
Capacity	<ul style="list-style-type: none"> - More than 130 shocks at 200 J at 20°C - More than 150 minutes of monitoring - More than 120 minutes of monitoring plus pacemaker (60 mA and 60 bpm)
Charging time	Approximately 3 hours
Weight	800 grams
AC mains	100-240 V AC and 50-60Hz
Continuous (Car battery)	10-16 V DC
Equipotential Conductor	It provides an additional connection to the ground connection of a building electrical installation. If this ground connection is not available, connect the equipotential conductor to any metal element accessible on the building structure.
ENVIRONMENTAL CONDITIONS	
Operating temperature	<ul style="list-style-type: none"> - 0°C to 50°C in Monitor mode and Defibrillator mode only, with installed battery pack and without any power supply connection - 0°C to 40°C connected to a power supply connection
Storage temperature	- -20°C to 60°C except for batteries and single-use multifunction electrodes
Relative humidity	10 to 95 %
Atmospheric Pressure (functioning)	Ambient to 525 mmHg (0 to 3,000 m)
Resistance to water	IPX2
Vibration	IEC 60068-2-64
Shock	IEC 60068-2-27
PHYSICAL CHARACTERISTICS	
Weight	- Device with recorder, reusable external paddles

and battery: 6.9 Kg

- Device with recorder, multifunction disposable electrodes and battery: 6.0 Kg
- Device with recorder, SpO2 option, AED, pacemaker, multifunction disposable electrodes and battery: 6.3 Kg
- Reusable external paddles: 0.95 Kg
- Battery: 0.8 Kg

Dimensions

195 mm high x 249 mm long x 310 mm wide

A.10 Waveform Specifications

For defibrillation the REANIBEX Serie 700 has incorporated a BIPHASIC TRUNCATED EXPONENTIAL WAVEFORM:

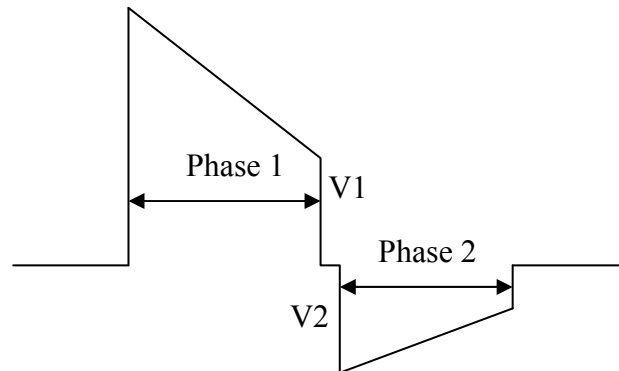

Switching time between Phase 1 and Phase 2 of the waveform is 600 μsec . Furthermore, it is designed so that the negative voltage (V2) coincides with the positive (V1) when the polarity changes.

The energy delivered during both phases depends upon the impedance of the patient, maximizing in this way the effectiveness of defibrillation.

The device delivers shocks with impedances that vary between 20 and 300 Ω . If the impedance is less than 20 Ω , it is assumed that a short circuit exists between the defibrillation electrodes. For impedance greater than 300 Ω , it will be assumed that the electrodes are badly connected to the patient, or that there is no patient connected, emitting the corresponding messages.

The energy delivered in each phase of the waveform is dynamically adjusted based on the impedance of the patient:

Charge Resistance (Ω)	Phase 1 Time (msec)	Phase 2 Time (msec)	Energy Delivered (J)
25	5.52	3.84	219
50	7.48	5.04	217
75	8.48	5.64	219
100	9.28	6.20	206
125	10.3	6.80	200
150	10.9	7.24	193
175	11.4	7.6	190

Clinical evaluation of the results obtained

At the present time, greater efficiency has been demonstrated for biphasic wave defibrillation than for traditional monophasic waves, since they require less energy for this purpose; it has also been observed that the displacements that this wave causes on the ST segment of the ECG are minor, presenting lower incidences of cardiac dysfunction after defibrillation.

A.11 Manufacturer’s Guide and Declaration of Electromagnetic Compatibility

The REANIBEX Serie 700 has been designed and tested to meet the requirements of the international standards for conducted and radiated emissions. The following tables provide detailed information on the Guide and Declaration for Electromagnetic Compatibility.

The lists of cables, transducers and other accessories that have been approved by the OSATU and conform to their requirements on immunity and emissions in Standard IEC 60601-1-2 are listed in Annex “A12. Accessories”.

WARNING: The use of accessories, transducers or cables which are different from those specified in this manual could result in an increase in emissions or reduce the immunity of the REANIBEX Serie 700.

El REANIBEX Serie 700 is designed to be used in the electromagnetic environments specified in the following tables. The user of the device must make sure that the device is utilized in these environments.

The following tables indicate the minimum separation distances that are recommended between the REANIBEX Serie 700 and portable and mobile communication devices.

ELECTROMAGNETIC EMISSIONS (EMC)		
The REANIBEX Serie 700 is designed for use in electromagnetic environments as specified below. The client or user of the REANIBEX Serie 700 must ensure that is used in this environment.		
Emission Test	Compliance	Electromagnetic environment- Guide
RF Emissions CISPR11	Group 1	The REANIBEX SERIE 700 uses RF energy only for its internal operation. Therefore, its emissions are very low and it is not probable that they would cause interference in nearby electronic equipment.
RF Emissions CISPR11	Group B	
Harmonic Emission IEC 61000 3-2	Class B	

Voltage fluctuations/Flicker Emission IEC 610003-3	Conforms	
Electrical Medical Equipment requires special precautions with respect to EMC and needs to be installed and put into service in accordance with the EMC information provided in this document.		

ELECTROMAGNETIC IMMUNITY			
The REANIBEX Serie 700 is designed for use in electromagnetic environments as specified below. The client or user of the REANIBEX Serie 700 must ensure that is used in this environment.			
Immunity Test	Test Level IEC 60601	Level of Compliance	Electromagnetic environment-Guide
Electrostatic Discharge (ESD) IEC 61000 -4-2	± 6 kV contact ± 8 kV air	± 6 kV contact ± 8 kV air	The flooring should be made of wood, concrete or ceramic. If the flooring is covered with synthetic material, the relative humidity should be at least 30%.
Fast/burst electric transients IEC 61000-4-4	± 2 kV for power supply lines ± 1 kV for input/output lines	Conforms Not applicable	
Impulses (Surges) IEC 61000-4-5	± 1 kV differential mode +/- 2 kV common mode	Conforms Conforms	
Voltage drops, short interruptions and changes in the voltage in the input power supply lines IEC 61000-4-11	<5% Ut (>95% drop in Ut) for 0.5 cycles 40% Ut (60% drop in Ut) for 5 cycles 70% Ut (30% drop in Ut) for 25 cycles >5% Ut (<95% drop in Ut) per 5 seconds	Conforms Conforms Conforms Conforms	
Magnetic field at power line	3 V/m	Conforms	The magnetic fields should be at levels characteristic of a typical

frequency (50/60Hz) IEC 61000-4-8			location in a commercial environment or a busy hospital environment
NOTE: U_t is the AC voltage before the test level application			

ELECTROMAGNETIC IMMUNITY			
<p>The REANIBEX Serie 700 is designed for use in electromagnetic environments such as those specified below. The client or user of the REANIBEX Serie 700 must ensure that is used in this environment.</p>			
Immunity Test	Test Level IEC 60601	Level of compliance	Electromagnetic environment-Guide
			RF mobile and portable communications devices must not be used next to any component of the REANIBEX SERIE 700, including the cables at recommended separation distances less than those calculated from the equation applicable to the transmitter frequency.
			Recommended separation distances
Conducted RF IEC 61000-4-6	3 Vrms 150 kHz at 80 MHz outside the ISM ^a bands	3 V	
	10 Vrms 150 kHz at 80 MHz in the ISM ^a bands	10 V	
Radiated RF IEC 61000-4-3	10 V/m 80 MHz at 2.5 GHz	20 V/m	$d = 0.6 \sqrt{P}$ of 80MHz at 800MHz $d = 1.15 \sqrt{P}$ of 800MHz at 2.5GHz
			P is the maximum output power magnitude of the transmitter in

			<p>Watts (W) according to the manufacturer of the transmitter, and d is the recommended separation distance in meters (m)^b</p> <p>The field intensity of fixed RF transmitters, as determined by measurement of the electromagnetic disturbance in the area, must be less than the compliance level in each frequency range^d</p> <p>Interference can occur within the vicinity of devices marked with the following symbol:</p> 
--	--	--	--

NOTE 1: At 80 MHz, the highest frequency range is applied.

NOTE 2: These utilization guidelines cannot be applied to every situation. Electromagnetic propagation is affected by absorption and reflection in structures, objects and people.

^a The ISM bands (industrial, scientific and medical) between 150 kHz and 80 MHz are from 6.75 MHz to 6.795 MHz; from 13.553 MHz to 13.567 MHz; from 26.975 MHz to 27.283 MHz; and from 40.66 MHz to 40.70 MHz.

^b The degree of compliance in the ISM frequency bands between 150 KHz and 80 MHz and in the range of frequencies from 80 MHz to 2.5 GHz, is designed to reduce the probability that mobile/portable communication equipment can cause interference if it is inadvertently brought into patient areas. For this reason, an additional factor of 10/3 is used in the calculation of the separation distances recommended in these frequency ranges.

^c The field intensity of fixed transmitters, such as base stations for radio (cellular and wireless), telephones, land mobile radios and amateur radios, AM and FM radio broadcasts, TV broadcasts, cannot be theoretically predicted with accuracy. To evaluate the electromagnetic environment due to RF fixed transmitters, an on-site measurement must be considered. If the field intensity measured in the location using REANIBEX SERIE 700 exceeds the applicable RF level of compliance, the REANIBEX SERIE 700 must be examined to verify normal operation. If abnormal operation is observed, additional measures will need to be taken such as reorientation or repositioning of the REANIBEX SERIE 700.

^d In regards to the range of frequencies from 150 kHz to 80 MHz, the field intensities must be less than (V_1) V/m

Recommended separation distances between RF mobile and portable communication devices and the REANIBEX Serie 700

The REANIBEX Serie 700 is designed for use in environments in which radiated RF interference is controlled. The client or the user of the REANIBEX Serie 700 can help to prevent electromagnetic interference by maintaining a minimal distance between RF mobile and portable communications equipment (transmitters) and the REANIBEX Serie 700 as is recommended below, in accordance with the maximum outlet power of the communication device.

Maximum output power of the transmitter W	Separation distances according to the transmitter frequency (m)			
	150 KHz to 80 MHz outside of the ISM bands $d = 1.16 \sqrt{P}$	150 KHz to 80 MHz within the ISM bands $d = 1.2 \sqrt{P}$	80 MHz to 800 MHz $d = 0.6 \sqrt{P}$	800 MHz to 2.5 GHz $d = 1.15 \sqrt{P}$
0.01	0.1	0.1	0.06	0.11
0.1	0.4	0.4	0.19	0.36
1	1.2	1.2	0.60	1.15
10	3.7	3.8	1.90	3.6
100	11.6	12	6.00	11.50

For transmitters with maximum output power not specified above, the recommended separation distance d in meters (m) can be determined using the equation applicable to the transmitter frequency, where P is the maximum output power in watts (W) according to the manufacturer of the transmitter

NOTE 1: At 80 MHz and 800 MHz, the separation distance is applied for the highest frequency

NOTE 2: The ISM bands (industrial, scientific and medical) between 150 kHz and 80 MHz are from 6.75 MHz to 6.795 MHz; from 13.553 MHz to 13.567 MHz; from 26.975 MHz to 27.283 MHz; and from 40.66 MHz to 40.70 MHz.

NOTE 3: An additional factor of 10/3 is used in the calculation of separation distances recommended in the ISM frequency bands between 150 kHz and 80 MHz and in the range of frequencies of 80 MHz to 2.5 GHz, to reduce the probability that the mobile/portable communication device might cause interference, if it is inadvertently taken to patient areas.

NOTE 4: These utilization guidelines cannot be applied to every situation. Electromagnetic propagation is affected by absorption and reflection in structures, objects and people.

Blank sheet

A.12 Accessories

DESCRIPTION	QUANTITY	STANDARD	OPTION
Adult/Paediatric External Reusable Paddles	1	√	
Internal Reusable Paddles			√
Single-use defibrillation electrodes with connector (Semi-Automatic Defibrillator and Pacemaker)	1	√	
4 Lead Patient Cable			√
5 Lead Patient Cable	1	√	
10 Lead Patient Cable			√
Single-use monitoring electrodes	1 bag	√	
Tube of gel	1	√	
Roll of recorder paper	2	√	
Rechargeable NiMH 12V CC battery	1	√	
Power cable	1	√	
Battery cable	1		√
Ground connection cable	1	√	
Certificate of guarantee	1	√	
Accessory Bag	1	√	
Carry Bag			√